



INCLUSIVE[®]
PROSTHETIC COMPONENTS

PRODUCT CATALOG

Introducing Inclusive® Prosthetic Components

Founded in 2006 with the goal of expanding the availability of comprehensive dental implant therapy to patients across the economic spectrum, PrismaTik Dentalcraft reduces the component and restorative cost of treatment while maintaining the highest standard of quality. Having assembled a diverse team of experts with decades of combined experience in the design, engineering, and manufacture of dental implants, along with a staff of highly respected researchers, material scientists, clinical specialists, restorative doctors, and dental technicians, we at PrismaTik are dedicated to advancing implant dentistry by combining proven treatment protocols with cutting-edge materials, technologies, and techniques.

Prosthetic components for the Inclusive® Tapered Implant System include a wide array of esthetic and multi-unit titanium abutments, along with analogs, screws, temporary and UCLA abutments, digital and conventional transfer copings, and more. PrismaTik Dentalcraft also has FDA 510(k) clearance for prosthetic connections that are compatible with several of the industry's other leading implant manufacturers. Prosthetic components manufactured by PrismaTik Dentalcraft are produced in an ISO 13485 certified environment in Irvine, California, operating under U.S. Food and Drug Administration Current Good Manufacturing Practices (CGMPs). This ensures tight tolerances, precision machining, state-of-the-art processing and cleaning, and extensive validation testing — from fatigue strength assessment to packaging integrity analysis. Uniform component costs across systems allow for predictable pricing. The result is a product that offers immediate value and lasting quality.

From its beginnings until today, PrismaTik Dentalcraft has experienced an ever-growing demand in support of its vision to make dental implant therapy more accessible to patients around the globe. This growth has enabled the company to consistently expand and improve its offerings even in a time of widespread economic challenge. The Inclusive brand has quickly established itself as a trusted name within the industry, and PrismaTik Dentalcraft as a manufacturer at the forefront of dental technology.

Thank you for choosing PrismaTik. You can place your trust in us.

Copyright © 2022, PrismaTik Dentalcraft, Inc. PrismaTik Dentalcraft, Inc. is not responsible for any damages or other liabilities (including attorney fees) resulting, or claimed to result in whole or in part, from actual or alleged problems arising out of the use of this information. The techniques, procedures and theories presented herein are provided in good faith and believed to be correct as of the date hereof. Any dental professional viewing this presentation must make his or her own decisions about the use of the materials and techniques for specific situations.

No representations as to the completeness or accuracy of this information is given, and no representations or warranties, either expressed or implied, of merchantability, fitness for a particular purpose or of any other nature are made here under with respect to the information or the product to which information refers.

Contents

| | |
|-----------|--|
| 5 | Inclusive® Tapered Implant System |
| | <i>Implant components compatible with the following third-party implant systems:</i> |
| 11 | BIOMET 3i™ Certain® |
| 15 | CAMLOG® SCREW-LINE |
| 19 | DENTSPLY Implants Ankylos® C/X |
| 21 | DENTSPLY Implants ASTRA TECH Implant System® |
| 24 | DENTSPLY Implants ASTRA TECH Implant System® EV |
| 26 | Hiossen® HG System |
| 29 | Keystone Dental PrimaConnex® |
| 29 | MegaGen AnyRidge® Implant System |
| 31 | Neoss® |
| 32 | Nobel Biocare Brånemark System® |
| 34 | Nobel Biocare NobelActive® |
| 37 | Nobel Biocare NobelReplace® |
| 41 | Straumann® Bone Level |
| 44 | Straumann® Tissue Level |
| 45 | Zimmer Dental Screw-Vent® |
| 47 | Parts Index |
| 58 | Product Packaging |
| 59 | Policies & Warranty |

*Inclusive is a registered trademark of Prismatic Dentalcraft, Inc.
BIOMET 3i is a trademark and CERTAIN a registered trademark of BIOMET 3i, LLC.
CAMLOG is a registered trademark of Camlog Biotechnologies AG.
ANKYLOS is a registered trademark of DeguDent GmbH.
ASTRA TECH IMPLANT SYSTEM is a registered trademark of Dentsply IH AB LLC.
HIOSSSEN is a registered trademark of OSSTEM IMPLANT Co., LTD.
PRIMACONNEX is a registered trademark of Keystone Dental, Inc.
ANYRIDGE is a registered trademark of MEGAGEN IMPLANT Co., LTD.
NEOSS is a registered trademark of Neoss Limited.
Brånemark System, NobelActive, and NobelReplace are registered trademarks of the Nobel Biocare group.
STRAUMANN is a registered trademark of Straumann Holding AG.
SCREW-VENT is a registered trademark of Zimmer Dental Inc.*



TECHNICAL SPECIFICATIONS



Ø3.2 mm

Ø3.7 mm

Ø4.2 mm

Ø4.7 mm

Ø5.2 mm

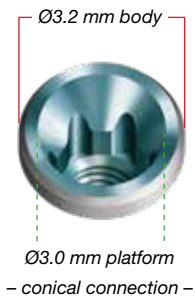



INCLUSIVE® TAPERED IMPLANT SYSTEM

DESCRIPTION

CODE

IMPLANT ANALOGS



70-1072-PRC0055

Inclusive® Tapered Implant Analog **3.0 mmP** 70-1072-PRC0055



70-1072-PRC0015

Inclusive® Tapered Implant Analog **3.5 mmP** 70-1072-PRC0015



70-1072-PRC0017

Inclusive® Tapered Implant Analog **4.5 mmP** 70-1072-PRC0017

IMPRESSION TRANSFERS



70-1072-PRC0051

Inclusive® Tapered Implant Transfer Coping, Closed-Tray, **3.0 mmP** x 3.2 mmD 70-1072-PRC0051



70-1072-PRC0053

Inclusive® Tapered Implant Transfer Coping, Closed-Tray, **3.0 mmP** x 3.7 mmD 70-1072-PRC0053



70-1072-PRC0007

Inclusive® Tapered Implant Transfer Coping, Closed-Tray, **3.5 mmP** x 3.5 mmD 70-1072-PRC0007



70-1072-PRC0009

Inclusive® Tapered Implant Transfer Coping, Closed-Tray, **3.5 mmP** x 4.7 mmD 70-1072-PRC0009



70-1072-PRC0011

Inclusive® Tapered Implant Transfer Coping, Closed-Tray, **4.5 mmP** x 4.5 mmD 70-1072-PRC0011



70-1072-PRC0013

Inclusive® Tapered Implant Transfer Coping, Closed-Tray, **4.5 mmP** x 5.7 mmD 70-1072-PRC0013

(Closed-Tray Transfer Copings include Closed-Tray Screw.)



70-1072-PRC0052

Inclusive® Tapered Implant Transfer Coping, Open-Tray, **3.0 mmP** x 3.2 mmD 70-1072-PRC0052



70-1072-PRC0054

Inclusive® Tapered Implant Transfer Coping, Open-Tray, **3.0 mmP** x 3.7 mmD 70-1072-PRC0054

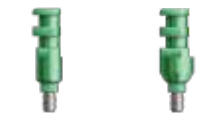

70-1072-PRC0006

Inclusive® Tapered Implant Transfer Coping, Open-Tray, **3.5 mmP** x 3.5 mmD 70-1072-PRC0006



70-1072-PRC0008

Inclusive® Tapered Implant Transfer Coping, Open-Tray, **3.5 mmP** x 4.7 mmD 70-1072-PRC0008



70-1072-PRC0010

Inclusive® Tapered Implant Transfer Coping, Open-Tray, **4.5 mmP** x 4.5 mmD 70-1072-PRC0010



70-1072-PRC0012

Inclusive® Tapered Implant Transfer Coping, Open-Tray, **4.5 mmP** x 5.7 mmD 70-1072-PRC0012

(Open-Tray Transfer Copings include Open-Tray Screw and Guide Pin.)



INCLUSIVE® TAPERED IMPLANT SYSTEM

DESCRIPTION

CODE

TITANIUM SCAN BODIES



70-1073-PRA0080

Inclusive® Tapered Implant Titanium Scan Body 3.0 mmP 70-1073-PRA0080



70-1073-PRA0081



70-1073-PRA0079

Inclusive® Tapered Implant Titanium Scan Body 3.5 mmP 70-1073-PRA0081

Inclusive® Tapered Implant Titanium Scan Body 4.5 mmP 70-1073-PRA0079
(Scan Bodies include captured screw.)

TEMPORARY ABUTMENTS



70-1073-PRA0048

Inclusive® Tapered Implant Temporary Abutment 3.0 mmP 70-1073-PRA0048



70-1073-PRA0022



70-1073-PRA0024

Inclusive® Tapered Implant Temporary Abutment 3.5 mmP 70-1073-PRA0022

Inclusive® Tapered Implant Temporary Abutment 4.5 mmP 70-1073-PRA0024



70-1073-PRA0047

Inclusive® Tapered Implant Temporary Abutment, Non-Engaging, 3.0 mmP 70-1073-PRA0047



70-1073-PRA0023



70-1073-PRA0025

Inclusive® Tapered Implant Temporary Abutment, Non-Engaging, 3.5 mmP 70-1073-PRA0023

Inclusive® Tapered Implant Temporary Abutment, Non-Engaging, 4.5 mmP 70-1073-PRA0025
(Temporary Abutments include Titanium Screw and Guide Pin.)

TITANIUM ABUTMENTS



70-1073-PRA0052



70-1073-PRA0053

Inclusive® Tapered Implant Titanium Abutment 3.0 mmP x 4.5 mmH 70-1073-PRA0052

Inclusive® Tapered Implant Titanium Abutment 3.0 mmP x 6 mmH 70-1073-PRA0053



70-1073-PRA0045



70-1073-PRA0006

Inclusive® Tapered Implant Titanium Abutment 3.5 mmP x 6 mmH 70-1073-PRA0006

Inclusive® Tapered Implant Titanium Abutment 3.5 mmP x 4.5 mmH 70-1073-PRA0045



70-1073-PRA0046



70-1073-PRA0008

Inclusive® Tapered Implant Titanium Abutment 4.5 mmP x 4.5 mmH 70-1073-PRA0046

Inclusive® Tapered Implant Titanium Abutment 4.5 mmP x 6 mmH 70-1073-PRA0008
(Titanium Screw sold separately; please see page 8.)



INCLUSIVE® TAPERED IMPLANT SYSTEM

DESCRIPTION

CODE

TITANIUM ESTHETIC ABUTMENTS

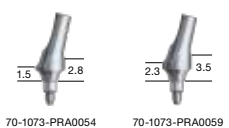

70-1073-PRA0054

Inclusive® Tapered Implant 15° Titanium Esthetic Abutment, Anterior, 3.0 mmP x 1.5 mmH 70-1073-PRA0054



70-1073-PRA0059

Inclusive® Tapered Implant 15° Titanium Esthetic Abutment, Anterior, 3.0 mmP x 2.3 mmH 70-1073-PRA0059



70-1073-PRA0009

Inclusive® Tapered Implant 15° Titanium Esthetic Abutment, Anterior, 3.5 mmP 70-1073-PRA0009



70-1073-PRA0010

Inclusive® Tapered Implant 15° Titanium Esthetic Abutment, Anterior, 4.5 mmP 70-1073-PRA0010



70-1073-PRA0013

Inclusive® Tapered Implant 15° Titanium Esthetic Abutment, Posterior, 4.5 mmP 70-1073-PRA0013



70-1073-PRA0055

Inclusive® Tapered Implant Titanium Esthetic Abutment, Anterior, 3.0 mmP x 1.5 mmH 70-1073-PRA0055



70-1073-PRA0060

Inclusive® Tapered Implant Titanium Esthetic Abutment, Anterior, 3.0 mmP x 2.3 mmH 70-1073-PRA0060



70-1073-PRA0011

Inclusive® Tapered Implant Titanium Esthetic Abutment, Anterior, 3.5 mmP 70-1073-PRA0011



70-1073-PRA0012

Inclusive® Tapered Implant Titanium Esthetic Abutment, Anterior, 4.5 mmP 70-1073-PRA0012



70-1073-PRA0014

Inclusive® Tapered Implant Titanium Esthetic Abutment, Posterior, 4.5 mmP 70-1073-PRA0014



70-1073-PRA0015

Inclusive® Tapered Implant Titanium Esthetic Abutment, Posterior, Wide, 4.5 mmP 70-1073-PRA0015
(*Esthetic Abutments include Titanium Screw.*)

UCLA ABUTMENTS



70-1073-PRA0058

Inclusive® Tapered Implant UCLA Plastic Abutment 3.0 mmP 70-1073-PRA0058



70-1073-PRA0018

Inclusive® Tapered Implant UCLA Plastic Abutment 3.5 mmP 70-1073-PRA0018



70-1073-PRA0020

Inclusive® Tapered Implant UCLA Plastic Abutment 4.5 mmP 70-1073-PRA0020



70-1073-PRA0057

Inclusive® Tapered Implant UCLA Plastic Abutment, Non-Engaging, 3.0 mmP 70-1073-PRA0057



70-1073-PRA0019

Inclusive® Tapered Implant UCLA Plastic Abutment, Non-Engaging, 3.5 mmP 70-1073-PRA0019



70-1073-PRA0021

Inclusive® Tapered Implant UCLA Plastic Abutment, Non-Engaging, 4.5 mmP 70-1073-PRA0021
(*UCLA Abutments include Titanium Screw and Guide Pin.*)



INCLUSIVE® TAPERED IMPLANT SYSTEM

DESCRIPTION

CODE

TITANIUM SCREWS AND GUIDE PINS



Inclusive® Tapered Implant Titanium Screw 3.0 mmP 70-1072-PRC0058
 Inclusive® Tapered Implant Titanium Screw 3.0 mmP (5-pack) 70-1072-PRC0057



Inclusive® Tapered Implant Titanium Screw 3.5/4.5 mmP 70-1072-PRC0001
 Inclusive® Tapered Implant Titanium Screw 3.5/4.5 mmP (5-pack) 70-1072-PRC0003



Inclusive® Tapered Implant Guide Pin 3.0 mmP (5-pack) 70-1072-PRC0056
 Inclusive® Tapered Implant Guide Pin 3.5/4.5 mmP (5-pack) 70-1072-PRC0002

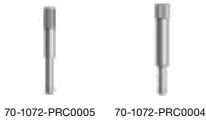

Inclusive® Tapered Implant Closed-Tray Transfer Screw 70-1072-PRC0005
 Inclusive® Tapered Implant Open-Tray Transfer Screw 70-1072-PRC0004

MULTI-UNIT ABUTMENTS

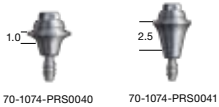

Inclusive® Tapered Implant Multi-Unit Abutment 3.0 mmP x 1.5 mmH 70-1074-PRS0040
 Inclusive® Tapered Implant Multi-Unit Abutment 3.0 mmP x 2.5 mmH 70-1074-PRS0041



Inclusive® Tapered Implant Multi-Unit Abutment 3.0 mmP x 3.5 mmH 70-1074-PRS0042

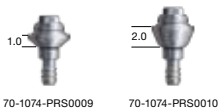

Inclusive® Tapered Implant Multi-Unit Abutment 3.5 mmP x 1 mmH 70-1074-PRS0009
 Inclusive® Tapered Implant Multi-Unit Abutment 3.5 mmP x 2 mmH 70-1074-PRS0010

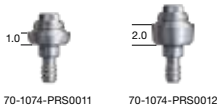

Inclusive® Tapered Implant Multi-Unit Abutment 4.5 mmP x 1 mmH 70-1074-PRS0011
 Inclusive® Tapered Implant Multi-Unit Abutment 4.5 mmP x 2 mmH 70-1074-PRS0012



Inclusive® Tapered Implant Multi-Unit Abutment 4.5 mmP x 3 mmH 70-1074-PRS0013
 Inclusive® Tapered Implant Multi-Unit Abutment 4.5 mmP x 5 mmH 70-1074-PRS0014
 (Prosthetic Screw sold separately; please see page 10.)



INCLUSIVE® TAPERED IMPLANT SYSTEM

DESCRIPTION

CODE

MULTI-UNIT ABUTMENTS

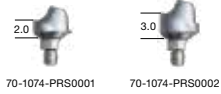

70-1074-PRS0001



70-1074-PRS0002

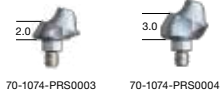

70-1074-PRS0003



70-1074-PRS0004



70-1074-PRS0005

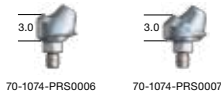

70-1074-PRS0006



70-1074-PRS0007



70-1074-PRS0008

Inclusive® Tapered Implant 17° Multi-Unit Abutment 3.5 mmP x 2 mmH 70-1074-PRS0001
Inclusive® Tapered Implant 17° Multi-Unit Abutment 3.5 mmP x 3 mmH 70-1074-PRS0002

Inclusive® Tapered Implant 17° Multi-Unit Abutment 4.5 mmP x 2 mmH 70-1074-PRS0003
Inclusive® Tapered Implant 17° Multi-Unit Abutment 4.5 mmP x 3 mmH 70-1074-PRS0004

Inclusive® Tapered Implant 17° Multi-Unit Abutment 4.5 mmP x 5 mmH 70-1074-PRS0005

Inclusive® Tapered Implant 30° Multi-Unit Abutment 3.5 mmP x 3 mmH..... 70-1074-PRS0006
Inclusive® Tapered Implant 30° Multi-Unit Abutment 4.5 mmP x 3 mmH..... 70-1074-PRS0007

Inclusive® Tapered Implant 30° Multi-Unit Abutment 4.5 mmP x 5 mmH..... 70-1074-PRS0008
(Angled Multi-Unit Abutments include Angled Abutment Screw. Prosthetic Screw sold separately; please see page 10.)

MULTI-UNIT TITANIUM SCREWS



70-1074-PRS0031

Inclusive® Angled Multi-Unit Abutment Screw 70-1074-PRS0031

INCLUSIVE® TAPERED IMPLANT SYSTEM

DESCRIPTION

CODE

MULTI-UNIT ABUTMENT ACCESSORIES



70-1074-PRS0016 70-1074-PRS0028

Inclusive® Multi-Unit Abutment Analog _____ 70-1074-PRS0016
 Inclusive® Multi-Unit Driver _____ 70-1074-PRS0028



70-1074-PRS0030 70-1074-PRS0018 70-1074-PRS0021

Inclusive® Multi-Unit Gold/Plastic Coping _____ 70-1074-PRS0030
 Inclusive® Multi-Unit Gold Bar Coping _____ 70-1074-PRS0018
 Inclusive® Multi-Unit Impression Coping, Closed-Tray _____ 70-1074-PRS0021



Inclusive® Multi-Unit Plastic Coping
 with Prosthetic Screw .048" Hex _____ 70-1074-PRS0068
 with Prosthetic Screw .050" Hex _____ 70-1074-PRS0067
 with Prosthetic Screw 1.0 mm Hex _____ 70-1074-PRS0071
 with Prosthetic Screw SCS _____ 70-1074-PRS0070
 with Prosthetic Screw - Unigrip™ Driver _____ 70-1074-PRS0069



Inclusive® Multi-Unit Impression Coping, Open-Tray
 with Guide Pin .048" Hex _____ 70-1074-PRS0053
 with Guide Pin .050" Hex _____ 70-1074-PRS0052
 with Guide Pin 1.0 mm Hex _____ 70-1074-PRS0055
 with Guide Pin SCS _____ 70-1074-PRS0054
 with Guide Pin - Unigrip™ Driver _____ 70-1074-PRS0022



Inclusive® Multi-Unit Temporary Healing Cap
 with Prosthetic Screw .048" Hex _____ 70-1074-PRS0043
 with Prosthetic Screw .050" Hex _____ 70-1074-PRS0015
 with Prosthetic Screw 1.0 mm Hex _____ 70-1074-PRS0046
 with Prosthetic Screw SCS _____ 70-1074-PRS0045
 with Prosthetic Screw - Unigrip™ Driver _____ 70-1074-PRS0044



Inclusive® Multi-Unit Coping 4.5 mmH, Non-Engaging
 with Prosthetic Screw .048" Hex _____ 70-1074-PRS0047
 with Prosthetic Screw .050" Hex _____ 70-1073-PRA0037
 with Prosthetic Screw 1.0 mm Hex _____ 70-1074-PRS0050
 with Prosthetic Screw SCS _____ 70-1074-PRS0049
 with Prosthetic Screw - Unigrip™ Driver _____ 70-1074-PRS0048



Inclusive® Multi-Unit Guide Pin
 .048" Hex _____ 70-1074-PRS0035
 .050" Hex _____ 70-1074-PRS0061
 1.0 mm Hex _____ 70-1074-PRS0036
 SCS _____ 70-1074-PRS0037
 Unigrip™ Driver _____ 70-1074-PRS0019



Inclusive® Multi-Unit Titanium Temporary
 with Prosthetic Screw .048" Hex _____ 70-1074-PRS0056
 with Prosthetic Screw .050" Hex _____ 70-1074-PRS0025
 with Prosthetic Screw 1.0 mm Hex _____ 70-1074-PRS0059
 with Prosthetic Screw SCS _____ 70-1074-PRS0058
 with Prosthetic Screw - Unigrip™ Driver _____ 70-1074-PRS0057



Inclusive® Multi-Unit Prosthetic Screw
 .048" Hex _____ 70-1047-COM0153
 .050" Hex _____ 70-1072-PRC0014
 1.0 mm Hex _____ 70-1072-PRC0046
 SCS _____ 70-1052-COM0088
 Unigrip™ Driver _____ 70-1072-PRC0043

DESCRIPTION (with platform size)

CODE

IMPLANT ANALOGS

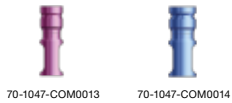

70-1047-COM0013

70-1047-COM0014

Inclusive® Implant Analog (5-pack)* 3.4 mm..... 70-1047-COM0013

Inclusive® Implant Analog (5-pack)* 4.1 mm..... 70-1047-COM0014



70-1047-COM0015

70-1047-COM0016

Inclusive® Implant Analog (5-pack)* 5.0 mm..... 70-1047-COM0015

Inclusive® Implant Analog (5-pack)* 6.0 mm..... 70-1047-COM0016

TITANIUM SCAN BODIES

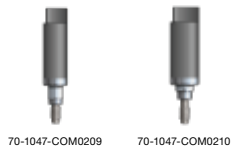

70-1047-COM0209

70-1047-COM0210

Inclusive® Titanium Scan Body* 3.4 mm..... 70-1047-COM0209

Inclusive® Titanium Scan Body* 4.1 mm..... 70-1047-COM0210

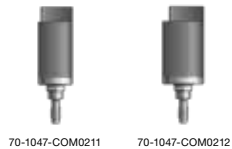

70-1047-COM0211

70-1047-COM0212

Inclusive® Titanium Scan Body* 5.0 mm..... 70-1047-COM0211

Inclusive® Titanium Scan Body* 6.0 mm..... 70-1047-COM0212

(Scan Bodies include captured screw.)

BITE VERIFICATION CYLINDERS

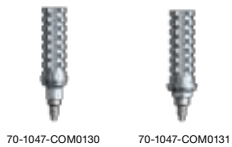

70-1047-COM0130

70-1047-COM0131

Inclusive® Bite Verification Cylinder* 3.4 mm..... 70-1047-COM0130

Inclusive® Bite Verification Cylinder* 4.1 mm..... 70-1047-COM0131

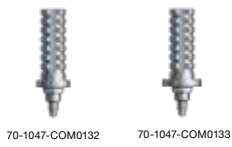

70-1047-COM0132

70-1047-COM0133

Inclusive® Bite Verification Cylinder* 5.0 mm..... 70-1047-COM0132

Inclusive® Bite Verification Cylinder* 6.0 mm..... 70-1047-COM0133

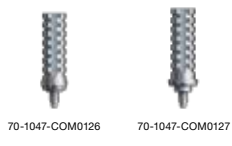

70-1047-COM0126

70-1047-COM0127

Inclusive® Bite Verification Cylinder, Non-Engaging* 3.4 mm..... 70-1047-COM0126

Inclusive® Bite Verification Cylinder, Non-Engaging* 4.1 mm..... 70-1047-COM0127



70-1047-COM0128

70-1047-COM0129

Inclusive® Bite Verification Cylinder, Non-Engaging* 5.0 mm..... 70-1047-COM0128

Inclusive® Bite Verification Cylinder, Non-Engaging* 6.0 mm..... 70-1047-COM0129

(Bite Verification Cylinders include Titanium Screw and Guide Pin.)

*compatible with: Biomet 3i™ Certain®

BIOMET 3i and Certain are trademarks of BIOMET 3i, LLC.

DESCRIPTION (with platform size)

CODE

TITANIUM ABUTMENTS



| | |
|--|-----------------|
| Inclusive® Titanium Abutment 4.5 mmH* 3.4 mm | 70-1047-COM0084 |
| Inclusive® Titanium Abutment 4.5 mmH* 4.1 mm | 70-1047-COM0086 |
| Inclusive® Titanium Abutment 4.5 mmH* 5.0 mm | 70-1047-COM0088 |
| Inclusive® Titanium Abutment 4.5 mmH* 6.0 mm | 70-1047-COM0090 |
| | |
| Inclusive® Titanium Abutment 6 mmH* 3.4 mm | 70-1047-COM0005 |
| Inclusive® Titanium Abutment 6 mmH* 4.1 mm | 70-1047-COM0006 |
| Inclusive® Titanium Abutment 6 mmH* 5.0 mm | 70-1047-COM0007 |
| Inclusive® Titanium Abutment 6 mmH* 6.0 mm | 70-1047-COM0008 |
| | |
| Inclusive® Titanium Abutment 4.5 mmH, Non-Engaging* 3.4 mm | 70-1047-COM0092 |
| Inclusive® Titanium Abutment 4.5 mmH, Non-Engaging* 4.1 mm | 70-1047-COM0094 |
| Inclusive® Titanium Abutment 4.5 mmH, Non-Engaging* 5.0 mm | 70-1047-COM0096 |
| Inclusive® Titanium Abutment 4.5 mmH, Non-Engaging* 6.0 mm | 70-1047-COM0098 |

(Titanium Screw sold separately; please see page 13.)

TITANIUM ESTHETIC ABUTMENTS

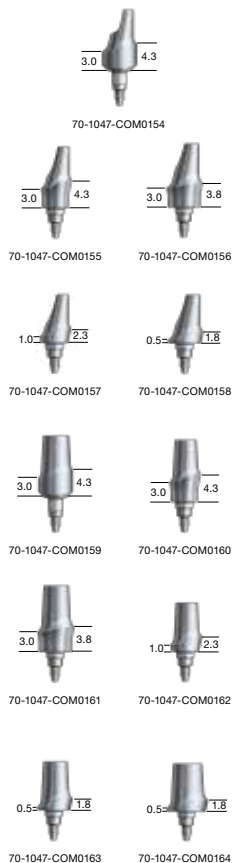

| | |
|--|-----------------|
| Inclusive® 15° Titanium Esthetic Abutment, Anterior* 3.4 mm | 70-1047-COM0154 |
| | |
| Inclusive® 15° Titanium Esthetic Abutment, Anterior* 4.1 mm | 70-1047-COM0155 |
| Inclusive® 15° Titanium Esthetic Abutment, Anterior* 5.0 mm | 70-1047-COM0156 |
| | |
| Inclusive® 15° Titanium Esthetic Abutment, Posterior* 4.1 mm | 70-1047-COM0157 |
| Inclusive® 15° Titanium Esthetic Abutment, Posterior* 5.0 mm | 70-1047-COM0158 |
| | |
| Inclusive® Titanium Esthetic Abutment, Anterior* 3.4 mm | 70-1047-COM0159 |
| Inclusive® Titanium Esthetic Abutment, Anterior* 4.1 mm | 70-1047-COM0160 |
| | |
| Inclusive® Titanium Esthetic Abutment, Anterior* 5.0 mm | 70-1047-COM0161 |
| Inclusive® Titanium Esthetic Abutment, Posterior* 4.1 mm | 70-1047-COM0162 |
| | |
| Inclusive® Titanium Esthetic Abutment, Posterior* 5.0 mm | 70-1047-COM0163 |
| Inclusive® Titanium Esthetic Abutment, Posterior* 6.0 mm | 70-1047-COM0164 |

(Esthetic Abutments include Titanium Screw.)

*compatible with: Biomet 3i™ Certain®

BIOMET 3i and Certain are trademarks of BIOMET 3i, LLC.

DESCRIPTION (with platform size)

CODE

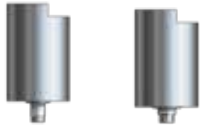

70-1047-COM0054 70-1047-COM0055

TITANIUM ABUTMENT BLANKS

| | |
|--|-----------------|
| Inclusive® Titanium Abutment Blank* 3.4 mm | 70-1047-COM0054 |
| Inclusive® Titanium Abutment Blank* 4.1 mm | 70-1047-COM0055 |

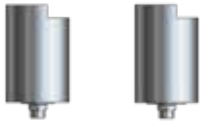

70-1047-COM0056 70-1047-COM0057

| | |
|--|-----------------|
| Inclusive® Titanium Abutment Blank* 5.0 mm | 70-1047-COM0056 |
| Inclusive® Titanium Abutment Blank* 6.0 mm | 70-1047-COM0057 |

(Titanium Screw sold separately; please see page 13.)

UCLA PLASTIC ABUTMENTS



70-1047-COM0165 70-1047-COM0166

| | |
|--|-----------------|
| Inclusive® UCLA Plastic Abutment* 3.4 mm | 70-1047-COM0165 |
| Inclusive® UCLA Plastic Abutment* 4.1 mm | 70-1047-COM0166 |

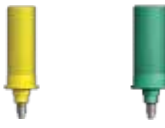

70-1047-COM0167 70-1047-COM0168

| | |
|--|-----------------|
| Inclusive® UCLA Plastic Abutment* 5.0 mm | 70-1047-COM0167 |
| Inclusive® UCLA Plastic Abutment* 6.0 mm | 70-1047-COM0168 |



70-1047-COM0169 70-1047-COM0170

| | |
|--|-----------------|
| Inclusive® UCLA Plastic Abutment, Non-Engaging* 3.4 mm | 70-1047-COM0169 |
| Inclusive® UCLA Plastic Abutment, Non-Engaging* 4.1 mm | 70-1047-COM0170 |

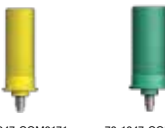

70-1047-COM0171 70-1047-COM0172

| | |
|--|-----------------|
| Inclusive® UCLA Plastic Abutment, Non-Engaging* 5.0 mm | 70-1047-COM0171 |
| Inclusive® UCLA Plastic Abutment, Non-Engaging* 6.0 mm | 70-1047-COM0172 |

(UCLA Abutments include Titanium Screw and Guide Pin.)

TITANIUM SCREWS AND GUIDE PINS



70-1047-COM0117
70-1047-COM0029

| | |
|--|-----------------|
| Inclusive® Titanium Screw* 3.4/4.1/5.0/6.0 mm | 70-1047-COM0117 |
| Inclusive® Titanium Screw (5-pack)* 3.4/4.1/5.0/6.0 mm | 70-1047-COM0029 |



70-1047-COM0112

| | |
|---|-----------------|
| Inclusive® Guide Pin (5-pack)* 3.4/4.1/5.0/6.0 mm | 70-1047-COM0112 |
|---|-----------------|

*compatible with: Biomet 3i™ Certain®
BIOMET 3i and Certain are trademarks of BIOMET 3i, LLC.

DESCRIPTION (with platform size)

CODE

MULTI-UNIT ABUTMENTS



Inclusive® Multi-Unit Abutment 1 mmH* 3.4 mm..... 70-1047-COM0134
 Inclusive® Multi-Unit Abutment 2 mmH* 3.4 mm..... 70-1047-COM0135
 Inclusive® Multi-Unit Abutment 3 mmH* 3.4 mm..... 70-1047-COM0136

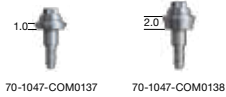

Inclusive® Multi-Unit Abutment 1 mmH* 4.1 mm 70-1047-COM0137
 Inclusive® Multi-Unit Abutment 2 mmH* 4.1 mm 70-1047-COM0138

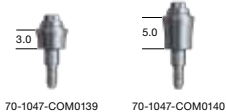

Inclusive® Multi-Unit Abutment 3 mmH* 4.1 mm 70-1047-COM0139
 Inclusive® Multi-Unit Abutment 5 mmH* 4.1 mm 70-1047-COM0140



Inclusive® Multi-Unit Abutment 1 mmH* 5.0 mm..... 70-1047-COM0141
 Inclusive® Multi-Unit Abutment 2 mmH* 5.0 mm..... 70-1047-COM0142
 Inclusive® Multi-Unit Abutment 3 mmH* 5.0 mm..... 70-1047-COM0143
(Prosthetic Screw sold separately; please see page 10.)

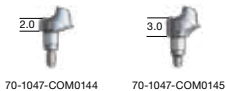

Inclusive® 17° Multi-Unit Abutment 2 mmH* 3.4 mm..... 70-1047-COM0144
 Inclusive® 17° Multi-Unit Abutment 3 mmH* 3.4 mm..... 70-1047-COM0145

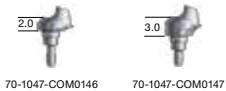

Inclusive® 17° Multi-Unit Abutment 2 mmH* 4.1 mm 70-1047-COM0146
 Inclusive® 17° Multi-Unit Abutment 3 mmH* 4.1 mm 70-1047-COM0147

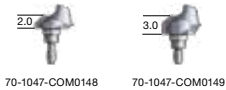

Inclusive® 17° Multi-Unit Abutment 2 mmH* 5.0 mm..... 70-1047-COM0148
 Inclusive® 17° Multi-Unit Abutment 3 mmH* 5.0 mm..... 70-1047-COM0149

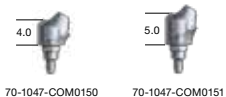

Inclusive® 30° Multi-Unit Abutment 4 mmH* 4.1 mm..... 70-1047-COM0150
 Inclusive® 30° Multi-Unit Abutment 5 mmH* 4.1 mm..... 70-1047-COM0151
(Angled Multi-Unit Abutments include Angled Abutment Screw. Prosthetic Screw sold separately; please see page 10.)



MULTI-UNIT TITANIUM SCREWS

Inclusive® Angled Multi-Unit Abutment Screw* 3.4/4.1/5.0/6.0 mm..... 70-1047-COM0152

MULTI-UNIT ABUTMENT ACCESSORIES

For a complete line of Multi-Unit Abutment Accessories, please see page 10.

*compatible with: Biomet 3i™ Certain®

BIOMET 3i and Certain are trademarks of BIOMET 3i, LLC.

DESCRIPTION (with platform size)

CODE

IMPLANT ANALOGS



70-1135-CAM0068 70-1135-CAM0070 70-1135-CAM0072

| | |
|---|-----------------|
| Inclusive® Implant Analog (5-pack)* 3.3 mm..... | 70-1135-CAM0068 |
| Inclusive® Implant Analog (5-pack)* 3.8 mm..... | 70-1135-CAM0070 |
| Inclusive® Implant Analog (5-pack)* 4.3 mm..... | 70-1135-CAM0072 |



70-1135-CAM0074 70-1135-CAM0076

| | |
|---|-----------------|
| Inclusive® Implant Analog (5-pack)* 5.0 mm..... | 70-1135-CAM0074 |
| Inclusive® Implant Analog (5-pack)* 6.0 mm..... | 70-1135-CAM0076 |

TITANIUM SCAN BODIES



70-1135-CAM0207 70-1135-CAM0208 70-1135-CAM0209

| | |
|--|-----------------|
| Inclusive® Titanium Scan Body* 3.3 mm..... | 70-1135-CAM0207 |
| Inclusive® Titanium Scan Body* 3.8 mm..... | 70-1135-CAM0208 |
| Inclusive® Titanium Scan Body* 4.3 mm..... | 70-1135-CAM0209 |

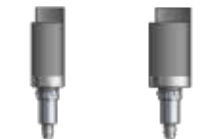

70-1135-CAM0210 70-1135-CAM0211

| | |
|--|-----------------|
| Inclusive® Titanium Scan Body* 5.0 mm..... | 70-1135-CAM0210 |
| Inclusive® Titanium Scan Body* 6.0 mm..... | 70-1135-CAM0211 |

(Scan Bodies include captured screw.)

BITE VERIFICATION CYLINDERS



70-1135-CAM0042 70-1135-CAM0044 70-1135-CAM0046

| | |
|--|-----------------|
| Inclusive® Bite Verification Cylinder* 3.3 mm..... | 70-1135-CAM0042 |
| Inclusive® Bite Verification Cylinder* 3.8 mm..... | 70-1135-CAM0044 |
| Inclusive® Bite Verification Cylinder* 4.3 mm..... | 70-1135-CAM0046 |



70-1135-CAM0048 70-1135-CAM0050

| | |
|--|-----------------|
| Inclusive® Bite Verification Cylinder* 5.0 mm..... | 70-1135-CAM0048 |
| Inclusive® Bite Verification Cylinder* 6.0 mm..... | 70-1135-CAM0050 |



70-1135-CAM0052 70-1135-CAM0054 70-1135-CAM0056

| | |
|---|-----------------|
| Inclusive® Bite Verification Cylinder, Non-Engaging* 3.3 mm | 70-1135-CAM0052 |
| Inclusive® Bite Verification Cylinder, Non-Engaging* 3.8 mm | 70-1135-CAM0054 |
| Inclusive® Bite Verification Cylinder, Non-Engaging* 4.3 mm | 70-1135-CAM0056 |

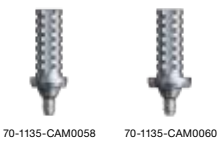

70-1135-CAM0058 70-1135-CAM0060

| | |
|---|-----------------|
| Inclusive® Bite Verification Cylinder, Non-Engaging* 5.0 mm | 70-1135-CAM0058 |
| Inclusive® Bite Verification Cylinder, Non-Engaging* 6.0 mm | 70-1135-CAM0060 |

(Bite Verification Cylinders include Titanium Screw and Guide Pin.)

*compatible with: Camlog® Screw-Line

CAMLOG is a registered trademark of Camlog Biotechnologies AG.

DESCRIPTION (with platform size)

CODE

TITANIUM ABUTMENTS



Inclusive® Titanium Abutment 4.5 mmH* 3.3 mm..... 70-1135-CAM0012
 Inclusive® Titanium Abutment 4.5 mmH* 3.8 mm..... 70-1135-CAM0014



Inclusive® Titanium Abutment 4.5 mmH* 4.3 mm..... 70-1135-CAM0016
 Inclusive® Titanium Abutment 4.5 mmH* 5.0 mm..... 70-1135-CAM0018



Inclusive® Titanium Abutment 4.5 mmH* 6.0 mm..... 70-1135-CAM0020



Inclusive® Titanium Abutment 6 mmH* 3.3 mm..... 70-1135-CAM0032
 Inclusive® Titanium Abutment 6 mmH* 3.8 mm..... 70-1135-CAM0034



Inclusive® Titanium Abutment 6 mmH* 4.3 mm..... 70-1135-CAM0036
 Inclusive® Titanium Abutment 6 mmH* 5.0 mm..... 70-1135-CAM0038



Inclusive® Titanium Abutment 6 mmH* 6.0 mm..... 70-1135-CAM0040



Inclusive® Titanium Abutment 4.5 mmH, Non-Engaging* 3.3 mm 70-1135-CAM0022
 Inclusive® Titanium Abutment 4.5 mmH, Non-Engaging* 3.8 mm 70-1135-CAM0024

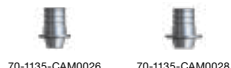

Inclusive® Titanium Abutment 4.5 mmH, Non-Engaging* 4.3 mm 70-1135-CAM0026
 Inclusive® Titanium Abutment 4.5 mmH, Non-Engaging* 5.0 mm 70-1135-CAM0028



Inclusive® Titanium Abutment 4.5 mmH, Non-Engaging* 6.0 mm 70-1135-CAM0030
 (Titanium Screw sold separately; please see page 17.)

TITANIUM ESTHETIC ABUTMENTS

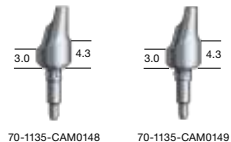

Inclusive® 15° Titanium Esthetic Abutment, Anterior* 3.3 mm 70-1135-CAM0148
 Inclusive® 15° Titanium Esthetic Abutment, Anterior* 3.8 mm 70-1135-CAM0149

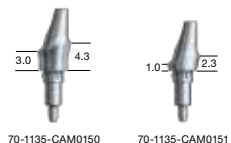

Inclusive® 15° Titanium Esthetic Abutment, Anterior* 4.3 mm 70-1135-CAM0150
 Inclusive® 15° Titanium Esthetic Abutment, Posterior* 4.3 mm 70-1135-CAM0151



Inclusive® 15° Titanium Esthetic Abutment, Posterior* 5.0 mm 70-1135-CAM0152
 (Esthetic Abutments include Titanium Screw.)

*compatible with: Camlog® Screw-Line

CAMLOG is a registered trademark of Camlog Biotechnologies AG.

DESCRIPTION (with platform size)

CODE

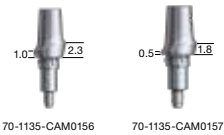

TITANIUM ESTHETIC ABUTMENTS

| | |
|---|-----------------|
| Inclusive® Titanium Esthetic Abutment, Anterior* 3.3 mm | 70-1135-CAM0153 |
| Inclusive® Titanium Esthetic Abutment, Anterior* 3.8 mm | 70-1135-CAM0154 |
| Inclusive® Titanium Esthetic Abutment, Anterior* 4.3 mm | 70-1135-CAM0155 |
| Inclusive® Titanium Esthetic Abutment, Posterior* 4.3 mm..... | 70-1135-CAM0156 |
| Inclusive® Titanium Esthetic Abutment, Posterior* 5.0 mm..... | 70-1135-CAM0157 |

(Esthetic Abutments include Titanium Screw.)

TITANIUM ABUTMENT BLANKS



| | |
|--|-----------------|
| Inclusive® Titanium Abutment Blank* 3.3 mm | 70-1135-CAM0117 |
| Inclusive® Titanium Abutment Blank* 3.8 mm | 70-1135-CAM0118 |
| Inclusive® Titanium Abutment Blank* 4.3 mm | 70-1135-CAM0119 |
| Inclusive® Titanium Abutment Blank* 5.0 mm | 70-1135-CAM0120 |
| Inclusive® Titanium Abutment Blank* 6.0 mm | 70-1135-CAM0121 |

(Titanium Screw sold separately; please see page 17.)

UCLA PLASTIC ABUTMENTS

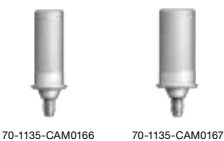

| | |
|--|-----------------|
| Inclusive® UCLA Plastic Abutment, Non-Engaging* 3.3 mm | 70-1135-CAM0163 |
| Inclusive® UCLA Plastic Abutment, Non-Engaging* 3.8 mm | 70-1135-CAM0164 |
| Inclusive® UCLA Plastic Abutment, Non-Engaging* 4.3 mm | 70-1135-CAM0165 |
| Inclusive® UCLA Plastic Abutment, Non-Engaging* 5.0 mm | 70-1135-CAM0166 |
| Inclusive® UCLA Plastic Abutment, Non-Engaging* 6.0 mm | 70-1135-CAM0167 |

(UCLA Abutments include Titanium Screw and Guide Pin.)

TITANIUM SCREWS AND GUIDE PINS

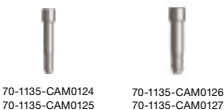

| | |
|---|-----------------|
| Inclusive® Titanium Screw* 3.3/3.8/4.3 mm | 70-1135-CAM0124 |
| Inclusive® Titanium Screw (5-pack)* 3.3/3.8/4.3 mm..... | 70-1135-CAM0125 |
| Inclusive® Titanium Screw* 5.0/6.0 mm | 70-1135-CAM0126 |
| Inclusive® Titanium Screw (5-pack)* 5.0/6.0 mm..... | 70-1135-CAM0127 |
| Inclusive® Guide Pin (5-pack)* 3.3/3.8/4.3 mm | 70-1135-CAM0064 |
| Inclusive® Guide Pin (5-pack)* 5.0/6.0 mm | 70-1135-CAM0066 |

*compatible with: Camlog® Screw-Line

CAMLOG is a registered trademark of Camlog Biotechnologies AG.

DESCRIPTION (with platform size)

CODE

MULTI-UNIT ABUTMENTS



Inclusive® Multi-Unit Abutment 1 mmH* 3.8 mm..... 70-1135-CAM0128
 Inclusive® Multi-Unit Abutment 2 mmH* 3.8 mm..... 70-1135-CAM0129
 Inclusive® Multi-Unit Abutment 3 mmH* 3.8 mm..... 70-1135-CAM0130

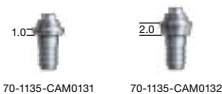

Inclusive® Multi-Unit Abutment 1 mmH* 4.3 mm..... 70-1135-CAM0131
 Inclusive® Multi-Unit Abutment 2 mmH* 4.3 mm..... 70-1135-CAM0132

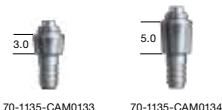

Inclusive® Multi-Unit Abutment 3 mmH* 4.3 mm..... 70-1135-CAM0133
 Inclusive® Multi-Unit Abutment 5 mmH* 4.3 mm..... 70-1135-CAM0134



Inclusive® Multi-Unit Abutment 1 mmH* 5.0 mm..... 70-1135-CAM0135
 Inclusive® Multi-Unit Abutment 2 mmH* 5.0 mm..... 70-1135-CAM0136
 Inclusive® Multi-Unit Abutment 3 mmH* 5.0 mm..... 70-1135-CAM0137
(Prosthetic Screw sold separately; please see page 10.)

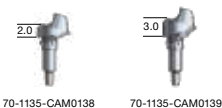

Inclusive® 17° Multi-Unit Abutment 2 mmH* 3.8 mm..... 70-1135-CAM0138
 Inclusive® 17° Multi-Unit Abutment 3 mmH* 3.8 mm..... 70-1135-CAM0139



Inclusive® 17° Multi-Unit Abutment 2 mmH* 4.3 mm..... 70-1135-CAM0140
 Inclusive® 17° Multi-Unit Abutment 3 mmH* 4.3 mm..... 70-1135-CAM0141
 Inclusive® 17° Multi-Unit Abutment 5 mmH* 4.3 mm..... 70-1135-CAM0142

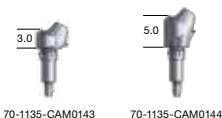

Inclusive® 30° Multi-Unit Abutment 3 mmH* 3.8 mm 70-1135-CAM0143
 Inclusive® 30° Multi-Unit Abutment 5 mmH* 3.8 mm 70-1135-CAM0144

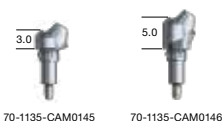

Inclusive® 30° Multi-Unit Abutment 3 mmH* 4.3 mm 70-1135-CAM0145
 Inclusive® 30° Multi-Unit Abutment 5 mmH* 4.3 mm 70-1135-CAM0146
(Angled Multi-Unit Abutments include Angled Abutment Screw. Prosthetic Screw sold separately; please see page 10.)



MULTI-UNIT TITANIUM SCREWS

Inclusive® Angled Multi-Unit Abutment Screw* 3.8/4.3 mm.....70-1135-CAM0147

MULTI-UNIT ABUTMENT ACCESSORIES

For a complete line of Multi-Unit Abutment Accessories, please see page 10.

*compatible with: Camlog® Screw-Line

CAMLOG is a registered trademark of Camlog Biotechnologies AG.

Implant components compatible with
DENTSPLY Implants Ankylos® C/X

DESCRIPTION *(with platform size)*

CODE



IMPLANT ANALOGS

| | |
|---|-----------------|
| Inclusive® Implant Analog (5-pack)* 3.5 A..... | 70-1139-COM0020 |
| Inclusive® Implant Analog (5-pack)* 4.5 B..... | 70-1139-COM0021 |
| Inclusive® Implant Analog (5-pack)* 5.5 C | 70-1139-COM0022 |



TITANIUM ABUTMENT BLANKS

| | |
|--|-----------------|
| Inclusive® Titanium Abutment Blank*..... | 70-1139-COM0013 |
|--|-----------------|

(Titanium Screw sold separately; please see page 19.)



TITANIUM SCREWS AND GUIDE PINS

| | |
|---|-----------------|
| Inclusive® Titanium Screw* | 70-1139-COM0014 |
| Inclusive® Titanium Screw (5-pack)* | 70-1139-COM0019 |
| Inclusive® Guide Pin (5-pack)* | 70-1139-COM0057 |

**compatible with: Dentsply Implants Ankylos® C/X*



BITE VERIFICATION CYLINDERS

| | |
|--|-----------------|
| Inclusive® Bite Verification Cylinder, Non-Engaging* | 70-1139-COM0048 |
|--|-----------------|

(Bite Verification Cylinders include Titanium Screw and Guide Pin.)



TITANIUM ABUTMENTS

| | |
|--|-----------------|
| Inclusive® Titanium Abutment 4.5 mmH, Non-Engaging* 3.5 A..... | 70-1139-COM0041 |
|--|-----------------|



| | |
|--|-----------------|
| Inclusive® Titanium Abutment 4.5 mmH, Non-Engaging* 4.5 B..... | 70-1139-COM0042 |
|--|-----------------|



| | |
|--|-----------------|
| Inclusive® Titanium Abutment 4.5 mmH, Non-Engaging* 5.5 C..... | 70-1139-COM0043 |
|--|-----------------|

(Titanium Screw sold separately; please see page 19.)



UCLA PLASTIC ABUTMENTS

| | |
|--|-----------------|
| Inclusive® UCLA Plastic Abutment, Non-Engaging*..... | 70-1139-COM0047 |
|--|-----------------|

(UCLA Abutments include Titanium Screw and Guide Pin.)

**compatible with: Dentsply Implants Ankylos® C/*

ANKYLOS is a registered trademark of DeguDent GmbH.

Implant components compatible with
DENTSPLY Implants Ankylos® C/X

DESCRIPTION *(with platform size)*

CODE



70-1139-COM0060

TITANIUM SCAN BODIES

Inclusive® Titanium Scan Body* 70-1139-COM0060
(Scan Bodies include captured screw.)



70-1139-COM0049

BITE VERIFICATION CYLINDERS

Inclusive® Bite Verification Cylinder* 70-1139-COM0049
(Bite Verification Cylinders include Titanium Screw and Guide Pin.)



70-1139-COM0045



70-1139-COM0046

TITANIUM ABUTMENTS

Inclusive® Titanium Abutment 4.5 mmH* 3.5 A 70-1139-COM0045
Inclusive® Titanium Abutment 6 mmH* 3.5 A 70-1139-COM0046
(Titanium Screw sold separately; please see page 19.)



70-1139-COM0052



70-1139-COM0053

TITANIUM ESTHETIC ABUTMENTS

Inclusive® 15° Titanium Esthetic Abutment, Anterior* 70-1139-COM0052
Inclusive® 15° Titanium Esthetic Abutment, Posterior* 70-1139-COM0053



70-1139-COM0050



70-1139-COM0051

Inclusive® Titanium Esthetic Abutment, Anterior* 70-1139-COM0050
Inclusive® Titanium Esthetic Abutment, Posterior* 70-1139-COM0051
(Esthetic Abutments include Titanium Screw.)



70-1139-COM0001



70-1139-COM0002

MULTI-UNIT ABUTMENTS

Inclusive® Multi-Unit Abutment 1.5 mmH* 70-1139-COM0001
Inclusive® Multi-Unit Abutment 2.5 mmH* 70-1139-COM0002



70-1139-COM0003



70-1139-COM0004

Inclusive® Multi-Unit Abutment 3.5 mmH* 70-1139-COM0003
Inclusive® Multi-Unit Abutment 4.5 mmH* 70-1139-COM0004
(Prosthetic Screw sold separately; please see page 10.)

MULTI-UNIT ABUTMENT ACCESSORIES

For a complete line of Multi-Unit Abutment Accessories, please see page 10.

**compatible with: Dentsply Implants Ankylos® IX*

ANKYLOS is a registered trademark of DeguDent GmbH.

Implant components compatible with
DENTSPLY Implants ASTRA TECH Implant System®

DESCRIPTION (with platform size)

CODE

IMPLANT ANALOGS



| | |
|---|-----------------|
| Inclusive® Implant Analog (5-pack)* 3.0 | 70-1048-COM0014 |
| Inclusive® Implant Analog (5-pack)* 3.5/4.0 | 70-1048-COM0016 |
| Inclusive® Implant Analog (5-pack)* 4.5/5.0 | 70-1048-COM0019 |

TITANIUM SCAN BODIES

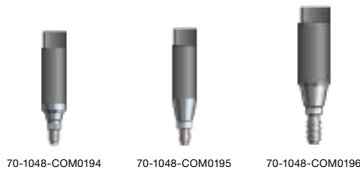

| | |
|--|-----------------|
| Inclusive® Titanium Scan Body* 3.0 | 70-1048-COM0194 |
| Inclusive® Titanium Scan Body* 3.5/4.0 | 70-1048-COM0195 |
| Inclusive® Titanium Scan Body* 4.5/5.0 | 70-1048-COM0196 |

(Scan Bodies include captured screw.)

BITE VERIFICATION CYLINDERS



| | |
|--|-----------------|
| Inclusive® Bite Verification Cylinder* 3.0 | 70-1048-COM0133 |
| Inclusive® Bite Verification Cylinder* 3.5/4.0 | 70-1048-COM0134 |
| Inclusive® Bite Verification Cylinder* 4.5/5.0 | 70-1048-COM0135 |
| Inclusive® Bite Verification Cylinder, Non-Engaging* 3.5/4.0 | 70-1048-COM0131 |
| Inclusive® Bite Verification Cylinder, Non-Engaging* 4.5/5.0 | 70-1048-COM0132 |

(Bite Verification Cylinders include Titanium Screw and Guide Pin.)

TITANIUM ABUTMENTS



| | |
|---|-----------------|
| Inclusive® Titanium Abutment 4.5 mmH* 3.0 | 70-1048-COM0089 |
| Inclusive® Titanium Abutment 4.5 mmH* 3.5/4.0 | 70-1048-COM0091 |
| Inclusive® Titanium Abutment 4.5 mmH* 4.5/5.0 | 70-1048-COM0093 |
| Inclusive® Titanium Abutment 6 mmH* 3.0 | 70-1048-COM0004 |
| Inclusive® Titanium Abutment 6 mmH* 3.5/4.0 | 70-1048-COM0005 |
| Inclusive® Titanium Abutment 6 mmH* 4.5/5.0 | 70-1048-COM0006 |
| Inclusive® Titanium Abutment 4.5 mmH, Non-Engaging* 3.5/4.0 | 70-1048-COM0097 |
| Inclusive® Titanium Abutment 4.5 mmH, Non-Engaging* 4.5/5.0 | 70-1048-COM0099 |

(Titanium Screw sold separately; please see page 22.)

TITANIUM ESTHETIC ABUTMENTS



| | |
|--|-----------------|
| Inclusive® 15° Titanium Esthetic Abutment, Anterior* 3.0 | 70-1048-COM0153 |
| Inclusive® 15° Titanium Esthetic Abutment, Anterior* 3.5/4.0 | 70-1048-COM0154 |
| Inclusive® 15° Titanium Esthetic Abutment, Anterior* 4.5/5.0 | 70-1048-COM0155 |

(Esthetic Abutments include Titanium Screw.)

**compatible with: Dentsply Implants Astra Tech Implant System®
Astra Tech Implant System is a registered trademark of Dentsply IH AB LLC.*

Implant components compatible with
DENTSPLY Implants ASTRA TECH Implant System®

DESCRIPTION (with platform size)

CODE



70-1048-COM0156



70-1048-COM0157

TITANIUM ESTHETIC ABUTMENTS

Inclusive® 15° Titanium Esthetic Abutment, Posterior* 3.5/4.0 70-1048-COM0156

Inclusive® 15° Titanium Esthetic Abutment, Posterior* 4.5/5.0 70-1048-COM0157



70-1048-COM0158



70-1048-COM0159



70-1048-COM0160

Inclusive® Titanium Esthetic Abutment, Anterior* 3.0..... 70-1048-COM0158

Inclusive® Titanium Esthetic Abutment, Anterior* 3.5/4.0 70-1048-COM0159

Inclusive® Titanium Esthetic Abutment, Anterior* 4.5/5.0 70-1048-COM0160



70-1048-COM0161



70-1048-COM0162

Inclusive® Titanium Esthetic Abutment, Posterior* 3.5/4.0..... 70-1048-COM0161

Inclusive® Titanium Esthetic Abutment, Posterior* 4.5/5.0..... 70-1048-COM0162

(Esthetic Abutments include Titanium Screw.)

TITANIUM ABUTMENT BLANKS



70-1048-COM0064



70-1048-COM0065



70-1048-COM0066

Inclusive® Titanium Abutment Blank* 3.0..... 70-1048-COM0064

Inclusive® Titanium Abutment Blank* 3.5/4.0..... 70-1048-COM0065

Inclusive® Titanium Abutment Blank* 4.5/5.0 70-1048-COM0066

(Titanium Screw sold separately; please see page 22.)

UCLA PLASTIC ABUTMENTS



70-1048-COM0163



70-1048-COM0164



70-1048-COM0165

Inclusive® UCLA Plastic Abutment* 3.0 70-1048-COM0163

Inclusive® UCLA Plastic Abutment* 3.5/4.0 70-1048-COM0164

Inclusive® UCLA Plastic Abutment* 4.5/5.0 70-1048-COM0165



70-1048-COM0166



70-1048-COM0167



70-1048-COM0168

Inclusive® UCLA Plastic Abutment, Non-Engaging* 3.0..... 70-1048-COM0166

Inclusive® UCLA Plastic Abutment, Non-Engaging* 3.5/4.0 70-1048-COM0167

Inclusive® UCLA Plastic Abutment, Non-Engaging* 4.5/5.0 70-1048-COM0168

(UCLA Abutments include Titanium Screw and Guide Pin.)

TITANIUM SCREWS AND GUIDE PINS



70-1048-COM0121
70-1048-COM0031

Inclusive® Titanium Screw* 3.0..... 70-1048-COM0121

Inclusive® Titanium Screw (5-pack)* 3.0 70-1048-COM0031



70-1048-COM0123
70-1048-COM0036



70-1048-COM0122
70-1048-COM0033

Inclusive® Titanium Screw* 3.5/4.0..... 70-1048-COM0122

Inclusive® Titanium Screw (5-pack)* 3.5/4.0 70-1048-COM0033

Inclusive® Titanium Screw* 4.5/5.0 70-1048-COM0123

Inclusive® Titanium Screw (5-pack)* 4.5/5.0 70-1048-COM0036

**compatible with: Dentsply Implants Astra Tech Implant System®*

Astra Tech Implant System is a registered trademark of Dentsply IH AB LLC.

Implant components compatible with
DENTSPLY Implants ASTRA TECH Implant System®

DESCRIPTION *(with platform size)*

CODE



TITANIUM SCREWS AND GUIDE PINS

| | |
|---|-----------------|
| Inclusive® Guide Pin (5-pack)* 3.0..... | 70-1048-COM0110 |
| Inclusive® Guide Pin (5-pack)* 3.5/4.0..... | 70-1048-COM0112 |
| Inclusive® Guide Pin (5-pack)* 4.5/5.0..... | 70-1048-COM0114 |



MULTI-UNIT ABUTMENTS

| | |
|--|-----------------|
| Inclusive® Multi-Unit Abutment 1.5 mmH* 3.5/4.0..... | 70-1048-COM0136 |
| Inclusive® Multi-Unit Abutment 2.5 mmH* 3.5/4.0..... | 70-1048-COM0137 |
| Inclusive® Multi-Unit Abutment 3.5 mmH* 3.5/4.0..... | 70-1048-COM0138 |



| | |
|--|-----------------|
| Inclusive® Multi-Unit Abutment 1.5 mmH* 4.5/5.0..... | 70-1048-COM0139 |
| Inclusive® Multi-Unit Abutment 2.5 mmH* 4.5/5.0..... | 70-1048-COM0140 |

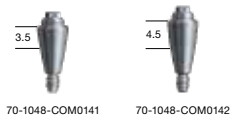

| | |
|--|-----------------|
| Inclusive® Multi-Unit Abutment 3.5 mmH* 4.5/5.0..... | 70-1048-COM0141 |
| Inclusive® Multi-Unit Abutment 4.5 mmH* 4.5/5.0..... | 70-1048-COM0142 |

(Prosthetic Screw sold separately; please see page 10.)

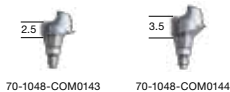

| | |
|--|-----------------|
| Inclusive® 17° Multi-Unit Abutment 2.5 mmH* 3.5/4.0..... | 70-1048-COM0143 |
| Inclusive® 17° Multi-Unit Abutment 3.5 mmH* 3.5/4.0..... | 70-1048-COM0144 |

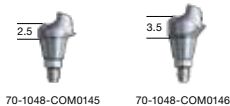

| | |
|--|-----------------|
| Inclusive® 17° Multi-Unit Abutment 2.5 mmH* 4.5/5.0..... | 70-1048-COM0145 |
| Inclusive® 17° Multi-Unit Abutment 3.5 mmH* 4.5/5.0..... | 70-1048-COM0146 |

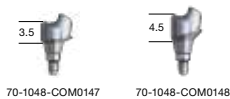

| | |
|--|-----------------|
| Inclusive® 30° Multi-Unit Abutment 3.5 mmH* 3.5/4.0..... | 70-1048-COM0147 |
| Inclusive® 30° Multi-Unit Abutment 4.5 mmH* 3.5/4.0..... | 70-1048-COM0148 |

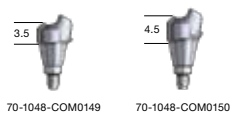

| | |
|--|-----------------|
| Inclusive® 30° Multi-Unit Abutment 3.5 mmH* 4.5/5.0..... | 70-1048-COM0149 |
| Inclusive® 30° Multi-Unit Abutment 4.5 mmH* 4.5/5.0..... | 70-1048-COM0150 |

(Angled Multi-Unit Abutments include Angled Abutment Screw. Prosthetic Screw sold separately; please see page 10.)

MULTI-UNIT TITANIUM SCREWS



| | |
|---|-----------------|
| Inclusive® Angled Multi-Unit Abutment Screw* 3.5/4.0..... | 70-1048-COM0151 |
| Inclusive® Angled Multi-Unit Abutment Screw* 4.5/5.0..... | 70-1048-COM0152 |

MULTI-UNIT ABUTMENT ACCESSORIES

For a complete line of Multi-Unit Abutment Accessories, please see page 10.

**compatible with: Dentsply Implants Astra Tech Implant System®
Astra Tech Implant System is a registered trademark of Dentsply IH AB LLC.*



Implant components compatible with DENTSPLY Implants ASTRA TECH Implant System® EV

DESCRIPTION (with platform size)

CODE

IMPLANT ANALOGS



70-1176-COM0249 70-1176-COM0250 70-1176-COM0251

| | |
|--------------------------------------|-----------------|
| Inclusive® Implant Analog* 3.0 | 70-1176-COM0249 |
| Inclusive® Implant Analog* 3.6 | 70-1176-COM0250 |
| Inclusive® Implant Analog* 4.2 | 70-1176-COM0251 |



70-1176-COM0252 70-1176-COM0253

| | |
|--------------------------------------|-----------------|
| Inclusive® Implant Analog* 4.8 | 70-1176-COM0252 |
| Inclusive® Implant Analog* 5.4 | 70-1176-COM0253 |

TITANIUM SCAN BODIES



70-1176-COM0388 70-1176-COM0384 70-1176-COM0385

| | |
|--|-----------------|
| Inclusive® Titanium Scan Body* 3.0 | 70-1176-COM0388 |
| Inclusive® Titanium Scan Body* 3.6 | 70-1176-COM0384 |
| Inclusive® Titanium Scan Body* 4.2 | 70-1176-COM0385 |



70-1176-COM0386 70-1176-COM0387

| | |
|--|-----------------|
| Inclusive® Titanium Scan Body* 4.8 | 70-1176-COM0386 |
| Inclusive® Titanium Scan Body* 5.4 | 70-1176-COM0387 |

BITE VERIFICATION CYLINDERS



70-1176-COM0298 70-1176-COM0299 70-1176-COM0300

| | |
|--|-----------------|
| Inclusive® Bite Verification Cylinder* 3.0 | 70-1176-COM0298 |
| Inclusive® Bite Verification Cylinder* 3.6 | 70-1176-COM0299 |
| Inclusive® Bite Verification Cylinder* 4.2 | 70-1176-COM0300 |



70-1176-COM0301 70-1176-COM0302

| | |
|--|-----------------|
| Inclusive® Bite Verification Cylinder* 4.8 | 70-1176-COM0301 |
| Inclusive® Bite Verification Cylinder* 5.4 | 70-1176-COM0302 |



70-1176-COM0293 70-1176-COM0294 70-1176-COM0295

| | |
|--|-----------------|
| Inclusive® Bite Verification Cylinder, Non-Engaging* 3.0 | 70-1176-COM0293 |
| Inclusive® Bite Verification Cylinder, Non-Engaging* 3.6 | 70-1176-COM0294 |
| Inclusive® Bite Verification Cylinder, Non-Engaging* 4.2 | 70-1176-COM0295 |



70-1176-COM0296 70-1176-COM0297

| | |
|--|-----------------|
| Inclusive® Bite Verification Cylinder, Non-Engaging* 4.8 | 70-1176-COM0296 |
| Inclusive® Bite Verification Cylinder, Non-Engaging* 5.4 | 70-1176-COM0297 |

(Bite Verification Cylinders include Titanium Screw and Guide Pin.)

**compatible with: Dentsply Implants Astra Tech Implant System® EV
Astra Tech Implant System is a registered trademark of Dentsply IH AB LLC.*



Implant components compatible with DENTSPLY Implants ASTRA TECH Implant System® EV

DESCRIPTION (with platform size)

CODE

TITANIUM ABUTMENTS



| | |
|---|-----------------|
| Inclusive® Titanium Abutment 4.5 mmH* 3.0 | 70-1176-COM0283 |
| Inclusive® Titanium Abutment 4.5 mmH* 3.6 | 70-1176-COM0284 |
| Inclusive® Titanium Abutment 4.5 mmH* 4.2 | 70-1176-COM0285 |
| Inclusive® Titanium Abutment 4.5 mmH* 4.8 | 70-1176-COM0286 |
| Inclusive® Titanium Abutment 4.5 mmH* 5.4 | 70-1176-COM0287 |



| | |
|---|-----------------|
| Inclusive® Titanium Abutment 6 mmH* 3.0 | 70-1176-COM0288 |
| Inclusive® Titanium Abutment 6 mmH* 3.6 | 70-1176-COM0289 |
| Inclusive® Titanium Abutment 6 mmH* 4.2 | 70-1176-COM0290 |
| Inclusive® Titanium Abutment 6 mmH* 4.8 | 70-1176-COM0291 |
| Inclusive® Titanium Abutment 6 mmH* 5.4 | 70-1176-COM0292 |



| | |
|---|-----------------|
| Inclusive® Titanium Abutment 4.5 mmH, Non-Engaging* 3.0 | 70-1176-COM0278 |
| Inclusive® Titanium Abutment 4.5 mmH, Non-Engaging* 3.6 | 70-1176-COM0279 |
| Inclusive® Titanium Abutment 4.5 mmH, Non-Engaging* 4.2 | 70-1176-COM0280 |
| Inclusive® Titanium Abutment 4.5 mmH, Non-Engaging* 4.8 | 70-1176-COM0281 |
| Inclusive® Titanium Abutment 4.5 mmH, Non-Engaging* 5.4 | 70-1176-COM0282 |

(Titanium Screw sold separately; please see page 25.)

TITANIUM ABUTMENT BLANKS



| | |
|---|-----------------|
| Inclusive® Tapered Implant Titanium Abutment Blank* 3.0 | 70-1176-COM0191 |
| Inclusive® Titanium Abutment Blank* 3.6 | 70-1176-COM0192 |
| Inclusive® Titanium Abutment Blank* 4.2 | 70-1176-COM0193 |
| Inclusive® Titanium Abutment Blank* 4.8 | 70-1176-COM0194 |
| Inclusive® Tapered Implant Titanium Abutment Blank* 5.4 | 70-1176-COM0195 |

(Titanium Screw sold separately; please see page 25.)

TITANIUM SCREWS AND GUIDE PINS



| | |
|--------------------------------------|-----------------|
| Inclusive® Titanium Screw* 3.0 | 70-1176-COM0254 |
| Inclusive® Titanium Screw* 3.6 | 70-1176-COM0255 |
| Inclusive® Titanium Screw* 4.2 | 70-1176-COM0256 |
| Inclusive® Titanium Screw* 4.8 | 70-1176-COM0257 |
| Inclusive® Titanium Screw* 5.4 | 70-1176-COM0258 |

**compatible with: Dentsply Implants Astra Tech Implant System® EV
Astra Tech Implant System is a registered trademark of Dentsply IH AB LLC.*



Implant components compatible with
DENTSPLY Implants ASTRA TECH Implant System® EV

DESCRIPTION *(with platform size)*

CODE

TITANIUM SCREWS AND GUIDE PINS



| | |
|-------------------------------------|-----------------|
| Inclusive® Guide Pin* 3.0 | 70-1176-COM0312 |
| Inclusive® Guide Pin* 3.6 | 70-1176-COM0313 |
| Inclusive® Guide Pin* 4.2 | 70-1176-COM0314 |
| Inclusive® Guide Pin* 4.8/5.4 | 70-1176-COM0315 |

**compatible with: Dentsply Implants Astra Tech Implant System® EV
 Astra Tech Implant System is a registered trademark of Dentsply IH AB LLC.*



Implant components compatible with **Hiossen® HG System**

DESCRIPTION *(with platform size)*

CODE

IMPLANT ANALOGS



| | |
|--|-----------------|
| Inclusive® Implant Analog (5-pack)* Standard | 70-1147-COM0017 |
| Inclusive® Implant Analog (5-pack)* Mini | 70-1147-COM0016 |

TITANIUM SCAN BODIES

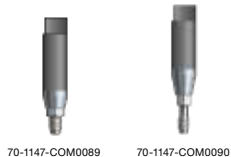

| | |
|---|-----------------|
| Inclusive® Titanium Scan Body* Standard | 70-1147-COM0089 |
| Inclusive® Titanium Scan Body* Mini | 70-1147-COM0090 |

(Scan Bodies include captured screw.)

BITE VERIFICATION CYLINDERS

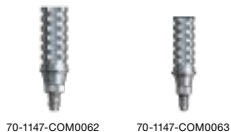

| | |
|---|-----------------|
| Inclusive® Bite Verification Cylinder* Standard | 70-1147-COM0062 |
| Inclusive® Bite Verification Cylinder* Mini | 70-1147-COM0063 |

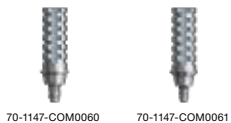

| | |
|---|-----------------|
| Inclusive® Bite Verification Cylinder, Non-Engaging* Standard | 70-1147-COM0060 |
| Inclusive® Bite Verification Cylinder, Non-Engaging* Mini | 70-1147-COM0061 |

(Bite Verification Cylinders include Titanium Screw and Guide Pin.)

TITANIUM ABUTMENTS



| | |
|--|-----------------|
| Inclusive® Titanium Abutment 4.5 mmH* Standard | 70-1147-COM0042 |
| Inclusive® Titanium Abutment 4.5 mmH* Mini | 70-1147-COM0043 |

**compatible with: Hiossen® HG System
 HIOSSEN is a registered trademark of OSSTEM IMPLANT Co., LTD.*

DESCRIPTION (with platform size)

CODE

TITANIUM ABUTMENTS



Inclusive® Titanium Abutment 6 mmH* Standard 70-1147-COM0046
 Inclusive® Titanium Abutment 6 mmH* Mini 70-1147-COM0047



Inclusive® Titanium Abutment 4.5 mmH, Non-Engaging* Standard 70-1147-COM0044
 Inclusive® Titanium Abutment 4.5 mmH, Non-Engaging* Mini..... 70-1147-COM0045
(Titanium Screw sold separately; please see page 27.)

TITANIUM ESTHETIC ABUTMENTS



Inclusive® 15° Titanium Esthetic Abutment, Anterior* Standard 70-1147-COM0052
 Inclusive® 15° Titanium Esthetic Abutment, Anterior* Mini..... 70-1147-COM0053



Inclusive® 15° Titanium Esthetic Abutment, Posterior* Standard 70-1147-COM0054
 Inclusive® 15° Titanium Esthetic Abutment, Posterior* Mini..... 70-1147-COM0055

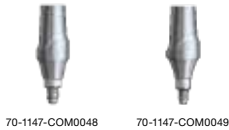

Inclusive® Titanium Esthetic Abutment, Anterior* Standard 70-1147-COM0048
 Inclusive® Titanium Esthetic Abutment, Anterior* Mini..... 70-1147-COM0049

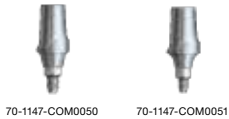

Inclusive® Titanium Esthetic Abutment, Posterior* Standard..... 70-1147-COM0050
 Inclusive® Titanium Esthetic Abutment, Posterior* Mini..... 70-1147-COM0051
(Esthetic Abutments include Titanium Screw.)

TITANIUM ABUTMENT BLANKS



Inclusive® Titanium Abutment Blank* Standard 70-1147-COM0009
 Inclusive® Titanium Abutment Blank* Mini 70-1147-COM0008
(Titanium Screw sold separately; please see page 27.)

UCLA PLASTIC ABUTMENTS

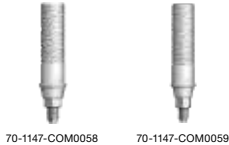

Inclusive® UCLA Plastic Abutment* Standard 70-1147-COM0058
 Inclusive® UCLA Plastic Abutment* Mini 70-1147-COM0059



Inclusive® UCLA Plastic Abutment, Non-Engaging* Standard 70-1147-COM0056
 Inclusive® UCLA Plastic Abutment, Non-Engaging* Mini..... 70-1147-COM0057
(UCLA Abutments include Titanium Screw and Guide Pin.)

TITANIUM SCREWS AND GUIDE PINS

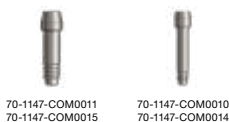

Inclusive® Titanium Screw* Standard..... 70-1147-COM0011
 Inclusive® Titanium Screw* Mini..... 70-1147-COM0010
 Inclusive® Titanium Screw (5-pack)* Standard 70-1147-COM0015
 Inclusive® Titanium Screw (5-pack)* Mini..... 70-1147-COM0014

*compatible with: Hiossen® HG System

HIOSSSEN is a registered trademark of OSSTEM IMPLANT Co., LTD.



Implant components compatible with Hiossen® HG System

DESCRIPTION (with platform size)

CODE

TITANIUM SCREWS AND GUIDE PINS



| | |
|--|-----------------|
| Inclusive® Guide Pin* Standard | 70-1147-COM0093 |
| Inclusive® Guide Pin* Mini | 70-1147-COM0094 |
| Inclusive® Guide Pin (5-pack)* Standard..... | 70-1147-COM0083 |
| Inclusive® Guide Pin (5-pack)* Mini | 70-1147-COM0084 |



MULTI-UNIT ABUTMENTS

| | |
|--|-----------------|
| Inclusive® Multi-Unit Abutment 1.5 mmH* Standard | 70-1147-COM0064 |
| Inclusive® Multi-Unit Abutment 1.5 mmH* Mini | 70-1147-COM0065 |
| Inclusive® Multi-Unit Abutment 2.5 mmH* Standard | 70-1147-COM0066 |
| Inclusive® Multi-Unit Abutment 2.5 mmH* Mini | 70-1147-COM0067 |
| Inclusive® Multi-Unit Abutment 3.5 mmH* Standard | 70-1147-COM0068 |
| Inclusive® Multi-Unit Abutment 3.5 mmH* Mini | 70-1147-COM0069 |



| | |
|--|-----------------|
| Inclusive® Multi-Unit Abutment 4.5 mmH* Standard | 70-1147-COM0070 |
|--|-----------------|

(Prosthetic Screw sold separately; please see page 10.)



| | |
|--|-----------------|
| Inclusive® 17° Multi-Unit Abutment 2.5 mmH* Standard..... | 70-1147-COM0071 |
| Inclusive® 17° Multi-Unit Abutment 2.5 mmH* Mini..... | 70-1147-COM0072 |
| Inclusive® 17° Multi-Unit Abutment 3.5 mmH* Standard..... | 70-1147-COM0073 |
| Inclusive® 17° Multi-Unit Abutment 3.5 mmH* Mini..... | 70-1147-COM0074 |
| Inclusive® 30° Multi-Unit Abutment 3.5 mmH* Standard | 70-1147-COM0075 |
| Inclusive® 30° Multi-Unit Abutment 3.5 mmH* Mini..... | 70-1147-COM0076 |
| Inclusive® 30° Multi-Unit Abutment 4.5 mmH* Standard | 70-1147-COM0077 |
| Inclusive® 30° Multi-Unit Abutment 4.5 mmH* Mini..... | 70-1147-COM0078 |

(Angled Multi-Unit Abutments include Angled Abutment Screw. Prosthetic Screw sold separately; please see page 10.)

MULTI-UNIT TITANIUM SCREWS



| | |
|---|-----------------|
| Inclusive® Angled Multi-Unit Abutment Screw* Standard | 70-1147-COM0079 |
| Inclusive® Angled Multi-Unit Abutment Screw* Mini | 70-1147-COM0080 |

MULTI-UNIT TITANIUM ACCESSORIES

For a complete line of Multi-Unit Abutment Accessories, please see page 10.

*compatible with: Hiossen® HG System

HIOSSSEN is a registered trademark of OSSTEM IMPLANT Co., LTD.

Implant components compatible with
Keystone Dental PrimaConnex®

DESCRIPTION *(with platform size)*

CODE



70-1055-COM0048 70-1055-COM0047



70-1055-COM0049

TITANIUM SCAN BODIES

| | |
|---|-----------------|
| Inclusive® Titanium Scan Body* RD | 70-1055-COM0048 |
| Inclusive® Titanium Scan Body* SD | 70-1055-COM0047 |

| | |
|---|-----------------|
| Inclusive® Titanium Scan Body* WD | 70-1055-COM0049 |
|---|-----------------|

(Scan Bodies include captured screw.)

**compatible with: Keystone Dental PrimaConnex®
 PrimaConnex is a registered trademark of Keystone Dental, Inc.*

Implant components compatible with
MegaGen AnyRidge® Implant System

DESCRIPTION *(with platform size)*

CODE



70-1173-COM0002



70-1173-COM0051

IMPLANT ANALOGS

| | |
|---|-----------------|
| Inclusive® Implant Analog (5-pack)* | 70-1173-COM0002 |
|---|-----------------|

TITANIUM SCAN BODIES

| | |
|--------------------------------------|-----------------|
| Inclusive® Titanium Scan Body* | 70-1173-COM0051 |
|--------------------------------------|-----------------|

(Scan Body includes captured screw.)



70-1173-COM0015 70-1173-COM0014

BITE VERIFICATION CYLINDERS

| | |
|--|-----------------|
| Inclusive® Bite Verification Cylinder* | 70-1173-COM0015 |
|--|-----------------|

| | |
|--|-----------------|
| Inclusive® Bite Verification Cylinder, Non-Engaging* | 70-1173-COM0014 |
|--|-----------------|

(Bite Verification Cylinders include Titanium Screw and Guide Pin.)



70-1173-COM0012 70-1173-COM0013



70-1173-COM0010 70-1173-COM0011

TITANIUM ABUTMENTS

| | |
|---|-----------------|
| Inclusive® Titanium Abutment 4.5 mmH* | 70-1173-COM0012 |
|---|-----------------|

| | |
|---|-----------------|
| Inclusive® Titanium Abutment 6 mmH* | 70-1173-COM0013 |
|---|-----------------|

| | |
|---|-----------------|
| Inclusive® Titanium Abutment 4.5 mmH, Non-Engaging* Ø3.5..... | 70-1173-COM0010 |
|---|-----------------|

| | |
|---|-----------------|
| Inclusive® Titanium Abutment 4.5 mmH, Non-Engaging* Ø5.0..... | 70-1173-COM0011 |
|---|-----------------|

(Titanium Screw sold separately; please see page 30.)

**compatible with: MegaGen AnyRidge® Implant System
 ANYRIDGE is a registered trademark of MEGAGEN IMPLANT Co., LTD.*



Implant components compatible with MegaGen AnyRidge® Implant System

DESCRIPTION *(with platform size)*

CODE



70-1173-COM0019

70-1173-COM0021

TITANIUM ESTHETIC ABUTMENTS

Inclusive® 15° Titanium Esthetic Abutment, Anterior* 70-1173-COM0019

Inclusive® 15° Titanium Esthetic Abutment, Posterior* 70-1173-COM0021



70-1173-COM0020

70-1173-COM0022

Inclusive® Titanium Esthetic Abutment, Anterior* 70-1173-COM0020

Inclusive® Titanium Esthetic Abutment, Posterior* 70-1173-COM0022

(Esthetic Abutments include Titanium Screw.)



70-1173-COM0003

TITANIUM ABUTMENT BLANKS

Inclusive® Titanium Abutment Blank* 70-1173-COM0003

(Titanium Screw sold separately; please see page 30.)



70-1173-COM0017

70-1173-COM0016

UCLA PLASTIC ABUTMENTS

Inclusive® UCLA Plastic Abutment* 70-1173-COM0017

Inclusive® UCLA Plastic Abutment, Non-Engaging* 70-1173-COM0016



70-1173-COM0004
70-1173-COM0001

TITANIUM SCREWS AND GUIDE PINS

Inclusive® Titanium Screw* 70-1173-COM0004

Inclusive® Titanium Screw (5-pack)* 70-1173-COM0001



70-1173-COM0018

Inclusive® Guide Pin (5-pack)* 70-1173-COM0018



70-1173-COM0023



70-1173-COM0024

MULTI-UNIT ABUTMENTS

Inclusive® Multi-Unit Abutment 2 mmH* 70-1173-COM0023

Inclusive® Multi-Unit Abutment 3 mmH* 70-1173-COM0024



70-1173-COM0025



70-1173-COM0026

Inclusive® Multi-Unit Abutment 4 mmH* 70-1173-COM0025

Inclusive® Multi-Unit Abutment 5 mmH* 70-1173-COM0026

**compatible with: MegaGen AnyRidge® Implant System
ANYRIDGE is a registered trademark of MEGAGEN IMPLANT Co., LTD.*

Implant components compatible with
MegaGen AnyRidge® Implant System

DESCRIPTION *(with platform size)*

CODE

MULTI-UNIT ABUTMENTS

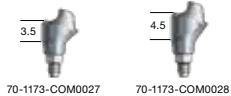

70-1173-COM0027

Inclusive® 17° Multi-Unit Abutment 3.5 mmH* 70-1173-COM0027



70-1173-COM0028

Inclusive® 17° Multi-Unit Abutment 4.5 mmH* 70-1173-COM0028



70-1173-COM0029

Inclusive® 17° Multi-Unit Abutment 5.5 mmH* 70-1173-COM0029



70-1173-COM0030

Inclusive® 30° Multi-Unit Abutment 3.5 mmH* 70-1173-COM0030



70-1173-COM0031

Inclusive® 30° Multi-Unit Abutment 4.5 mmH* 70-1173-COM0031



70-1173-COM0032

Inclusive® 30° Multi-Unit Abutment 5.5 mmH* 70-1173-COM0032



70-1173-COM0033

Inclusive® 30° Multi-Unit Abutment 6.5 mmH* 70-1173-COM0033



70-1173-COM0034

MULTI-UNIT TITANIUM SCREWS

Inclusive® Angled Multi-Unit Abutment Screw* 70-1173-COM0034

MULTI-UNIT ABUTMENT ACCESSORIES

For a complete line of Multi-Unit Abutment Accessories, please see page 10.

**compatible with: MegaGen AnyRidge® Implant System
 ANYRIDGE is a registered trademark of MEGAGEN IMPLANT Co., LTD.*

Implant components compatible with **Neoss®**

DESCRIPTION *(with platform size)*

CODE

TITANIUM SCAN BODIES



70-1056-COM0016

Inclusive® Titanium Scan Body* 4.0 mm 70-1056-COM0016
(Scan Body includes captured screw.)

**compatible with: Neoss®
 Neoss is a registered trademark of Neoss Limited.*

Implant components compatible with
Nobel Biocare Brånemark System®

DESCRIPTION (with platform size)

CODE



70-1049-COM0006

IMPLANT ANALOGS

Inclusive® Implant Analog (5-pack)* RP 70-1049-COM0006



70-1049-COM0074

TITANIUM SCAN BODIES

Inclusive® Titanium Scan Body* RP 70-1049-COM0074
(Scan Body includes captured screw.)



70-1049-COM0047

BITE VERIFICATION CYLINDERS

Inclusive® Bite Verification Cylinder* RP 70-1049-COM0047



70-1049-COM0044

Inclusive® Bite Verification Cylinder, Non-Engaging* RP 70-1049-COM0044
(Bite Verification Cylinders include Titanium Screw Unigrip™ and Guide Pin Unigrip™.)



70-1049-COM0024

TITANIUM ABUTMENTS

Inclusive® Titanium Abutment 4.5 mmH* RP 70-1049-COM0024



70-1049-COM0002

Inclusive® Titanium Abutment 6 mmH* RP 70-1049-COM0002



70-1049-COM0026

Inclusive® Titanium Abutment 4.5 mmH, Non-Engaging* RP 70-1049-COM0026
(Titanium Screw Unigrip™ sold separately; please see page 33.)



70-1049-COM0016

TITANIUM ABUTMENT BLANKS

Inclusive® Titanium Abutment Blank* RP 70-1049-COM0016
(Titanium Screw sold separately; please see page 33.)



70-1049-COM0063

UCLA PLASTIC ABUTMENTS

Inclusive® UCLA Plastic Abutment* RP 70-1049-COM0063



70-1049-COM0064

Inclusive® UCLA Plastic Abutment, Non-Engaging* RP 70-1049-COM0064
(UCLA Abutments include Titanium Screw Unigrip™ and Guide Pin Unigrip™.)

*compatible with: Nobel Biocare Brånemark System®

Dentsply Implants Astra Tech Implant System is a registered trademark of Dentsply IH AB LLC.



Implant components compatible with Nobel Biocare Brånemark System®

DESCRIPTION (with platform size)

CODE



70-1049-COM0040
70-1049-COM0011

TITANIUM SCREWS AND GUIDE PINS (UNIGRIP™)

| | |
|--|-----------------|
| Inclusive® Titanium Screw* RP | 70-1049-COM0040 |
| Inclusive® Titanium Screw (5-pack)* RP | 70-1049-COM0011 |

MULTI-UNIT ABUTMENTS



70-1049-COM0049



70-1049-COM0050



70-1049-COM0051



70-1049-COM0052

| | |
|--|-----------------|
| Inclusive® Multi-Unit Abutment 1 mmH* RP | 70-1049-COM0049 |
| Inclusive® Multi-Unit Abutment 2 mmH* RP | 70-1049-COM0050 |
| Inclusive® Multi-Unit Abutment 3 mmH* RP | 70-1049-COM0051 |
| Inclusive® Multi-Unit Abutment 5 mmH* RP | 70-1049-COM0052 |

(Prosthetic Screw sold separately; please see page 10.)



70-1049-COM0053



70-1049-COM0054



70-1049-COM0055

| | |
|--|-----------------|
| Inclusive® 17° Multi-Unit Abutment 2 mmH* RP | 70-1049-COM0053 |
| Inclusive® 17° Multi-Unit Abutment 3 mmH* RP | 70-1049-COM0054 |
| Inclusive® 17° Multi-Unit Abutment 4 mmH* RP | 70-1049-COM0055 |



70-1049-COM0056



70-1049-COM0057

| | |
|--|-----------------|
| Inclusive® 30° Multi-Unit Abutment 4 mmH* RP | 70-1049-COM0056 |
| Inclusive® 30° Multi-Unit Abutment 5 mmH* RP | 70-1049-COM0057 |

(Angled Multi-Unit Abutments include Angled Abutment Screw. Prosthetic Screw sold separately; please see page 10.)

MULTI-UNIT TITANIUM SCREWS



70-1049-COM0058

| | |
|---|-----------------|
| Inclusive® Angled Multi-Unit Abutment Screw* RP | 70-1049-COM0058 |
|---|-----------------|

MULTI-UNIT ABUTMENT ACCESSORIES

For a complete line of Multi-Unit Abutment Accessories, please see page 10.

**compatible with: Nobel Biocare Brånemark System®*

Dentsply Implants Astra Tech Implant System is a registered trademark of Dentsply IH AB LLC.

Implant components compatible with Nobel Biocare NobelActive®

DESCRIPTION (with platform size)

CODE

IMPLANT ANALOGS



Inclusive® Implant Analog (5-pack)* NP 70-1050-COM0001
 Inclusive® Implant Analog (5-pack)* RP 70-1050-COM0002

TITANIUM SCAN BODIES



Inclusive® Titanium Scan Body* NP 70-1050-COM0139
 Inclusive® Titanium Scan Body* RP 70-1050-COM0140
(Scan Bodies include captured screw.)

BITE VERIFICATION CYLINDERS

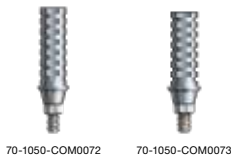

Inclusive® Bite Verification Cylinder* NP 70-1050-COM0072
 Inclusive® Bite Verification Cylinder* RP 70-1050-COM0073

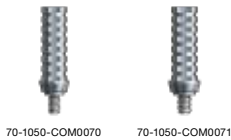

Inclusive® Bite Verification Cylinder, Non-Engaging* NP 70-1050-COM0070
 Inclusive® Bite Verification Cylinder, Non-Engaging* RP 70-1050-COM0071
(Bite Verification Cylinders include Titanium Screw Unigrip™ and Guide Pin Unigrip™.)

TITANIUM ABUTMENTS

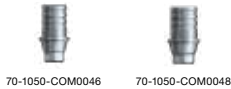

Inclusive® Titanium Abutment 4.5 mmH* NP 70-1050-COM0046
 Inclusive® Titanium Abutment 4.5 mmH* RP 70-1050-COM0048

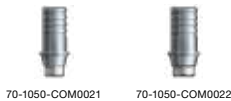

Inclusive® Titanium Abutment 6 mmH* NP 70-1050-COM0021
 Inclusive® Titanium Abutment 6 mmH* RP 70-1050-COM0022



Inclusive® Titanium Abutment 4.5 mmH, Non-Engaging* NP 70-1050-COM0050
 Inclusive® Titanium Abutment 4.5 mmH, Non-Engaging* RP 70-1050-COM0052
(Titanium Screw Unigrip™ sold separately; please see page 35.)

TITANIUM ESTHETIC ABUTMENTS

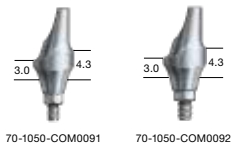

Inclusive® 15° Titanium Esthetic Abutment, Anterior* NP 70-1050-COM0091
 Inclusive® 15° Titanium Esthetic Abutment, Anterior* RP 70-1050-COM0092

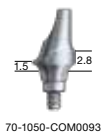

Inclusive® 15° Titanium Esthetic Abutment, Posterior* RP 70-1050-COM0093
(Esthetic Abutments include Titanium Screw Unigrip™.)

*compatible with: Nobel Biocare NobelActive®

NobelActive and Unigrip are trademarks of the Nobel Biocare group.

Implant components compatible with
Nobel Biocare NobelActive®

DESCRIPTION *(with platform size)*

CODE



TITANIUM ESTHETIC ABUTMENTS

Inclusive® Titanium Esthetic Abutment, Anterior* NP 70-1050-COM0094
 Inclusive® Titanium Esthetic Abutment, Anterior* RP 70-1050-COM0095



Inclusive® Titanium Esthetic Abutment, Posterior* RP 70-1050-COM0096
(Esthetic Abutments include Titanium Screw Unigrip™.)



TITANIUM ABUTMENT BLANKS

Inclusive® Titanium Abutment Blank* NP 70-1050-COM0029
 Inclusive® Titanium Abutment Blank* RP 70-1050-COM0030
(Titanium Screw sold separately; please see page 35.)



UCLA PLASTIC ABUTMENTS

Inclusive® UCLA Plastic Abutment* NP 70-1050-COM0097
 Inclusive® UCLA Plastic Abutment* RP 70-1050-COM0098



Inclusive® UCLA Plastic Abutment, Non-Engaging* NP 70-1050-COM0099
 Inclusive® UCLA Plastic Abutment, Non-Engaging* RP 70-1050-COM0100
(UCLA Abutments include Titanium Screw Unigrip™ and Guide Pin Unigrip™.)

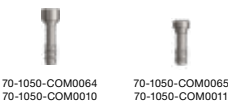

TITANIUM SCREWS AND GUIDE PINS (UNIGRIP™)

Inclusive® Titanium Screw* NP 70-1050-COM0064
 Inclusive® Titanium Screw (5-pack)* NP 70-1050-COM0010
 Inclusive® Titanium Screw* RP 70-1050-COM0065
 Inclusive® Titanium Screw (5-pack)* RP 70-1050-COM0011

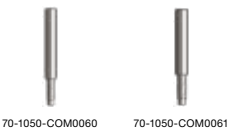

Inclusive® Guide Pin Implant Level 20 mm (5-pack)* NP 70-1050-COM0060
 Inclusive® Guide Pin Implant Level 20 mm (5-pack)* RP 70-1050-COM0061
(Unigrip™ driver required.)

**compatible with: Nobel Biocare NobelActive®
 NobelActive and Unigrip are trademarks of the Nobel Biocare group.*

Implant components compatible with
Nobel Biocare NobelActive®

DESCRIPTION *(with platform size)*

CODE

MULTI-UNIT ABUTMENTS

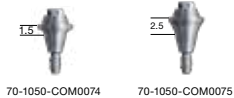

70-1050-COM0074



70-1050-COM0075



70-1050-COM0076

Inclusive® Multi-Unit Abutment 1.5 mmH* NP 70-1050-COM0074

Inclusive® Multi-Unit Abutment 2.5 mmH* NP 70-1050-COM0075

Inclusive® Multi-Unit Abutment 3.5 mmH* NP 70-1050-COM0076



70-1050-COM0077



70-1050-COM0078

Inclusive® Multi-Unit Abutment 1.5 mmH* RP 70-1050-COM0077

Inclusive® Multi-Unit Abutment 2.5 mmH* RP 70-1050-COM0078



70-1050-COM0079



70-1050-COM0080

Inclusive® Multi-Unit Abutment 3.5 mmH* RP 70-1050-COM0079

Inclusive® Multi-Unit Abutment 4.5 mmH* RP 70-1050-COM0080

(Prosthetic Screw sold separately; please see page 10.)



70-1050-COM0081



70-1050-COM0082

Inclusive® 17° Multi-Unit Abutment 2.5 mmH* NP 70-1050-COM0081

Inclusive® 17° Multi-Unit Abutment 3.5 mmH* NP 70-1050-COM0082



70-1050-COM0083



70-1050-COM0084

Inclusive® 17° Multi-Unit Abutment 2.5 mmH* RP 70-1050-COM0083

Inclusive® 17° Multi-Unit Abutment 3.5 mmH* RP 70-1050-COM0084



70-1050-COM0085



70-1050-COM0086

Inclusive® 30° Multi-Unit Abutment 3.5 mmH* NP 70-1050-COM0085

Inclusive® 30° Multi-Unit Abutment 4.5 mmH* NP 70-1050-COM0086



70-1050-COM0087



70-1050-COM0088

Inclusive® 30° Multi-Unit Abutment 3.5 mmH* RP 70-1050-COM0087

Inclusive® 30° Multi-Unit Abutment 4.5 mmH* RP 70-1050-COM0088

(Angled Multi-Unit Abutments include Angled Abutment Screw. Prosthetic Screw sold separately; please see page 10.)

MULTI-UNIT TITANIUM SCREWS



70-1050-COM0089



70-1050-COM0090

Inclusive® Angled Multi-Unit Abutment Screw* NP 70-1050-COM0089

Inclusive® Angled Multi-Unit Abutment Screw* RP 70-1050-COM0090

MULTI-UNIT ABUTMENT ACCESSORIES

For a complete line of Multi-Unit Abutment Accessories, please see page 10.

**compatible with: Nobel Biocare NobelActive®*

NobelActive and Unigrip are trademarks of the Nobel Biocare group.



Implant components compatible with Nobel Biocare NobelReplace®

DESCRIPTION (with platform size)

CODE

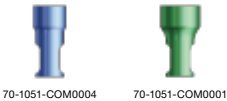
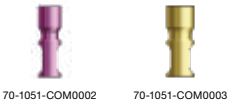

IMPLANT ANALOGS

| | |
|---|-----------------|
| Inclusive® Implant Analog (5-pack)* NP | 70-1051-COM0002 |
| Inclusive® Implant Analog (5-pack)* RP | 70-1051-COM0003 |
| Inclusive® Implant Analog (5-pack)* WP | 70-1051-COM0004 |
| Inclusive® Implant Analog (5-pack)* 6.0 | 70-1051-COM0001 |



IMPRESSION TRANSFERS

| | |
|---|-----------------|
| Inclusive® Transfer Coping 3.5 mmD, Closed-Tray* NP | 70-1051-COM0235 |
| Inclusive® Transfer Coping 4.3 mmD, Closed-Tray* RP | 70-1051-COM0236 |
| Inclusive® Transfer Coping 5.0 mmD, Closed-Tray* WP | 70-1051-COM0237 |
| Inclusive® Transfer Coping 3.5 mmD, Open-Tray* NP | 70-1051-COM0238 |
| Inclusive® Transfer Coping 4.3 mmD, Open-Tray* RP | 70-1051-COM0239 |
| Inclusive® Transfer Coping 5.0 mmD, Open-Tray* WP | 70-1051-COM0240 |

(Open-Tray Transfer Copings include Open-Tray Screw and Guide Pin.)

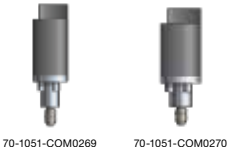
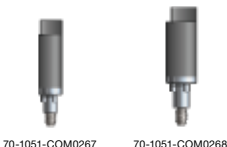

TITANIUM SCAN BODIES

| | |
|--|-----------------|
| Inclusive® Titanium Scan Body* NP | 70-1051-COM0267 |
| Inclusive® Titanium Scan Body* RP | 70-1051-COM0268 |
| Inclusive® Titanium Scan Body* WP | 70-1051-COM0269 |
| Inclusive® Titanium Scan Body* 6.0 | 70-1051-COM0270 |

(Scan Body includes captured screw.)

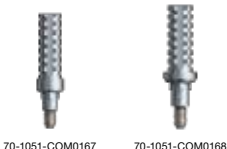

BITE VERIFICATION CYLINDERS

| | |
|---|-----------------|
| Inclusive® Bite Verification Cylinder* NP | 70-1051-COM0167 |
| Inclusive® Bite Verification Cylinder* RP | 70-1051-COM0168 |
| Inclusive® Bite Verification Cylinder* WP | 70-1051-COM0169 |
| Inclusive® Bite Verification Cylinder* 6.0 | 70-1051-COM0170 |
| Inclusive® Bite Verification Cylinder, Non-Engaging* NP | 70-1051-COM0163 |
| Inclusive® Bite Verification Cylinder, Non-Engaging* RP | 70-1051-COM0164 |

(Bite Verification Cylinders include Titanium Screw Unigrip™ and Guide Pin Unigrip™.)

*compatible with: Nobel Biocare NobelReplace®
NobelReplace and Unigrip are trademarks of the Nobel Biocare group.



Implant components compatible with Nobel Biocare NobelReplace®

DESCRIPTION (with platform size)

CODE

BITE VERIFICATION CYLINDERS

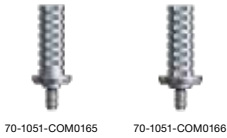

| | |
|--|-----------------|
| Inclusive® Bite Verification Cylinder, Non-Engaging* WP | 70-1051-COM0165 |
| Inclusive® Bite Verification Cylinder, Non-Engaging* 6.0 | 70-1051-COM0166 |

(Bite Verification Cylinders include Titanium Screw Unigrip™ and Guide Pin Unigrip™.)

TITANIUM ABUTMENTS



| | |
|---|-----------------|
| Inclusive® Titanium Abutment 4.5 mmH* NP | 70-1051-COM0090 |
| Inclusive® Titanium Abutment 4.5 mmH* RP | 70-1051-COM0092 |
| Inclusive® Titanium Abutment 4.5 mmH* WP | 70-1051-COM0094 |
| Inclusive® Titanium Abutment 4.5 mmH* 6.0 | 70-1051-COM0088 |
| Inclusive® Titanium Abutment 6 mmH* NP | 70-1051-COM0048 |
| Inclusive® Titanium Abutment 6 mmH* RP | 70-1051-COM0049 |
| Inclusive® Titanium Abutment 6 mmH* WP | 70-1051-COM0050 |
| Inclusive® Titanium Abutment 6 mmH* 6.0 | 70-1051-COM0047 |

| | |
|---|-----------------|
| Inclusive® Titanium Abutment 4.5 mmH, Non-Engaging* NP | 70-1051-COM0098 |
| Inclusive® Titanium Abutment 4.5 mmH, Non-Engaging* RP | 70-1051-COM0100 |
| Inclusive® Titanium Abutment 4.5 mmH, Non-Engaging* WP | 70-1051-COM0102 |
| Inclusive® Titanium Abutment 4.5 mmH, Non-Engaging* 6.0 | 70-1051-COM0096 |

(Titanium Screw Unigrip™ sold separately; please see page 39.)

TITANIUM ESTHETIC ABUTMENTS

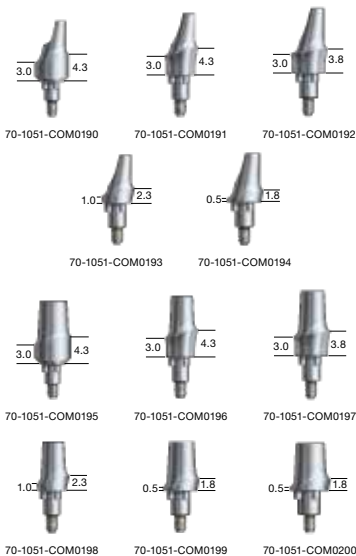

| | |
|--|-----------------|
| Inclusive® 15° Titanium Esthetic Abutment, Anterior* NP | 70-1051-COM0190 |
| Inclusive® 15° Titanium Esthetic Abutment, Anterior* RP | 70-1051-COM0191 |
| Inclusive® 15° Titanium Esthetic Abutment, Anterior* WP | 70-1051-COM0192 |
| Inclusive® 15° Titanium Esthetic Abutment, Posterior* RP | 70-1051-COM0193 |
| Inclusive® 15° Titanium Esthetic Abutment, Posterior* WP | 70-1051-COM0194 |
| Inclusive® Titanium Esthetic Abutment, Anterior* NP | 70-1051-COM0195 |
| Inclusive® Titanium Esthetic Abutment, Anterior* RP | 70-1051-COM0196 |
| Inclusive® Titanium Esthetic Abutment, Anterior* WP | 70-1051-COM0197 |
| Inclusive® Titanium Esthetic Abutment, Posterior* RP | 70-1051-COM0198 |
| Inclusive® Titanium Esthetic Abutment, Posterior* WP | 70-1051-COM0199 |
| Inclusive® Titanium Esthetic Abutment, Posterior* 6.0 | 70-1051-COM0200 |

(Esthetic Abutments include Titanium Screw Unigrip™.)

***compatible with: Nobel Biocare NobelReplace®
NobelReplace and Unigrip are trademarks of the Nobel Biocare group.*



Implant components compatible with Nobel Biocare NobelReplace®

DESCRIPTION (with platform size)

CODE

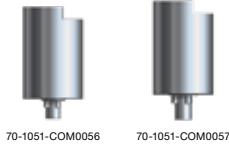

70-1051-COM0056 70-1051-COM0057

TITANIUM ABUTMENT BLANKS

| | |
|---|-----------------|
| Inclusive® Titanium Abutment Blank* NP..... | 70-1051-COM0056 |
| Inclusive® Titanium Abutment Blank* RP..... | 70-1051-COM0057 |



70-1051-COM0058 70-1051-COM0055

| | |
|--|-----------------|
| Inclusive® Titanium Abutment Blank* WP..... | 70-1051-COM0058 |
| Inclusive® Titanium Abutment Blank* 6.0..... | 70-1051-COM0055 |

(Titanium Screw sold separately; please see page 39.)

UCLA PLASTIC ABUTMENTS

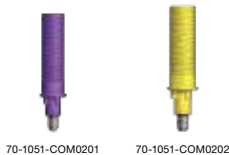

70-1051-COM0201 70-1051-COM0202

| | |
|---|-----------------|
| Inclusive® UCLA Plastic Abutment* NP..... | 70-1051-COM0201 |
| Inclusive® UCLA Plastic Abutment* RP..... | 70-1051-COM0202 |



70-1051-COM0203 70-1051-COM0204

| | |
|--|-----------------|
| Inclusive® UCLA Plastic Abutment* WP..... | 70-1051-COM0203 |
| Inclusive® UCLA Plastic Abutment* 6.0..... | 70-1051-COM0204 |



70-1051-COM0205 70-1051-COM0206

| | |
|---|-----------------|
| Inclusive® UCLA Plastic Abutment, Non-Engaging* NP..... | 70-1051-COM0205 |
| Inclusive® UCLA Plastic Abutment, Non-Engaging* RP..... | 70-1051-COM0206 |



70-1051-COM0207 70-1051-COM0208

| | |
|--|-----------------|
| Inclusive® UCLA Plastic Abutment, Non-Engaging* WP..... | 70-1051-COM0207 |
| Inclusive® UCLA Plastic Abutment, Non-Engaging* 6.0..... | 70-1051-COM0208 |

(UCLA Abutments include Titanium Screw Unigrip™ and Guide Pin Unigrip™.)

TITANIUM SCREWS AND GUIDE PINS (UNIGRIP™)



70-1051-COM0153
70-1051-COM0019

| | |
|---|-----------------|
| Inclusive® Titanium Screw* NP..... | 70-1051-COM0153 |
| Inclusive® Titanium Screw (5-pack)* NP..... | 70-1051-COM0019 |



70-1051-COM0154
70-1051-COM0020

| | |
|--|-----------------|
| Inclusive® Titanium Screw* RP/WP/6.0..... | 70-1051-COM0154 |
| Inclusive® Titanium Screw (5-pack)* RP/WP/6.0..... | 70-1051-COM0020 |

**compatible with: Nobel Biocare NobelReplace®
NobelReplace and Unigrip are trademarks of the Nobel Biocare group.*



Implant components compatible with Nobel Biocare NobelReplace®

DESCRIPTION (with platform size)

CODE



TITANIUM SCREWS AND GUIDE PINS (UNIGRIP™)

| | |
|---|-----------------|
| Inclusive® Guide Pin Implant Level 20 mm (5-pack)* NP | 70-1051-COM0142 |
| Inclusive® Guide Pin (5-pack)* RP/WP/6.0 | 70-1051-COM0144 |

(Unigrip™ driver required.)



MULTI-UNIT ABUTMENTS

| | |
|--|-----------------|
| Inclusive® Multi-Unit Abutment 1 mmH* NP | 70-1051-COM0171 |
| Inclusive® Multi-Unit Abutment 2 mmH* NP | 70-1051-COM0172 |
| Inclusive® Multi-Unit Abutment 3 mmH* NP | 70-1051-COM0173 |

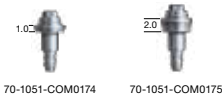

| | |
|--|-----------------|
| Inclusive® Multi-Unit Abutment 1 mmH* RP | 70-1051-COM0174 |
| Inclusive® Multi-Unit Abutment 2 mmH* RP | 70-1051-COM0175 |

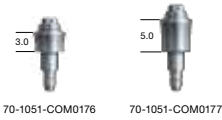

| | |
|--|-----------------|
| Inclusive® Multi-Unit Abutment 3 mmH* RP | 70-1051-COM0176 |
| Inclusive® Multi-Unit Abutment 5 mmH* RP | 70-1051-COM0177 |



| | |
|--|-----------------|
| Inclusive® Multi-Unit Abutment 1 mmH* WP | 70-1051-COM0178 |
| Inclusive® Multi-Unit Abutment 2 mmH* WP | 70-1051-COM0179 |
| Inclusive® Multi-Unit Abutment 3 mmH* WP | 70-1051-COM0180 |

(Prosthetic Screw sold separately; please see page 10.)

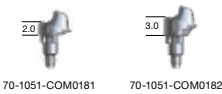

| | |
|--|-----------------|
| Inclusive® 17° Multi-Unit Abutment 2 mmH* NP | 70-1051-COM0181 |
| Inclusive® 17° Multi-Unit Abutment 3 mmH* NP | 70-1051-COM0182 |



| | |
|--|-----------------|
| Inclusive® 17° Multi-Unit Abutment 2 mmH* RP | 70-1051-COM0183 |
| Inclusive® 17° Multi-Unit Abutment 3 mmH* RP | 70-1051-COM0184 |
| Inclusive® 17° Multi-Unit Abutment 4 mmH* RP | 70-1051-COM0185 |

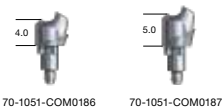

| | |
|--|-----------------|
| Inclusive® 30° Multi-Unit Abutment 4 mmH* RP | 70-1051-COM0186 |
| Inclusive® 30° Multi-Unit Abutment 5 mmH* RP | 70-1051-COM0187 |

(Angled Multi-Unit Abutments include Angled Abutment Screw. Prosthetic Screw sold separately; please see page 10.)

MULTI-UNIT TITANIUM SCREWS



| | |
|---|-----------------|
| Inclusive® Angled Multi-Unit Abutment Screw* NP | 70-1051-COM0188 |
| Inclusive® Angled Multi-Unit Abutment Screw* RP | 70-1051-COM0189 |

MULTI-UNIT ABUTMENT ACCESSORIES

For a complete line of Multi-Unit Abutment Accessories, please see page 10.

**compatible with: Nobel Biocare NobelReplace®*

NobelReplace and Unigrip are trademarks of the Nobel Biocare group.



Implant components compatible with Straumann® Bone Level

DESCRIPTION (with platform size)

CODE

IMPLANT ANALOGS

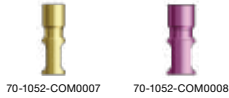

70-1052-COM0007 70-1052-COM0008

| | |
|---|-----------------|
| Inclusive® Implant Analog (5-pack)* NC..... | 70-1052-COM0007 |
| Inclusive® Implant Analog (5-pack)* RC..... | 70-1052-COM0008 |

TITANIUM SCAN BODIES

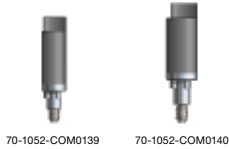

70-1052-COM0139 70-1052-COM0140

| | |
|--|-----------------|
| Inclusive® Titanium Scan Body* NC..... | 70-1052-COM0139 |
| Inclusive® Titanium Scan Body* RC..... | 70-1052-COM0140 |

(Scan Body includes captured screw.)

BITE VERIFICATION CYLINDERS



70-1052-COM0072 70-1052-COM0073

| | |
|--|-----------------|
| Inclusive® Bite Verification Cylinder* NC..... | 70-1052-COM0072 |
| Inclusive® Bite Verification Cylinder* RC..... | 70-1052-COM0073 |

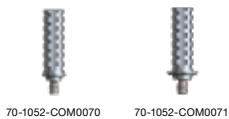

70-1052-COM0070 70-1052-COM0071

| | |
|--|-----------------|
| Inclusive® Bite Verification Cylinder, Non-Engaging* NC..... | 70-1052-COM0070 |
| Inclusive® Bite Verification Cylinder, Non-Engaging* RC..... | 70-1052-COM0071 |

(Bite Verification Cylinders include SCS Titanium Screw and SCS Guide Pin.)

TITANIUM ABUTMENTS

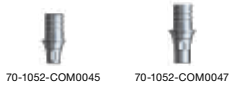

70-1052-COM0045 70-1052-COM0047

| | |
|---|-----------------|
| Inclusive® Titanium Abutment 4.5 mmH* NC..... | 70-1052-COM0045 |
| Inclusive® Titanium Abutment 4.5 mmH* RC..... | 70-1052-COM0047 |



70-1052-COM0003 70-1052-COM0004

| | |
|---|-----------------|
| Inclusive® Titanium Abutment 6 mmH* NC..... | 70-1052-COM0003 |
| Inclusive® Titanium Abutment 6 mmH* RC..... | 70-1052-COM0004 |



70-1052-COM0049 70-1052-COM0051

| | |
|---|-----------------|
| Inclusive® Titanium Abutment 4.5 mmH, Non-Engaging* NC..... | 70-1052-COM0049 |
| Inclusive® Titanium Abutment 4.5 mmH, Non-Engaging* RC..... | 70-1052-COM0051 |

(SCS Titanium Screw sold separately; please see below.)

TITANIUM ESTHETIC ABUTMENTS

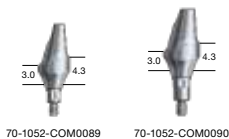

70-1052-COM0089 70-1052-COM0090

| | |
|--|-----------------|
| Inclusive® 15° Titanium Esthetic Abutment, Anterior* NC..... | 70-1052-COM0089 |
| Inclusive® 15° Titanium Esthetic Abutment, Anterior* RC..... | 70-1052-COM0090 |

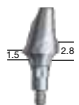

70-1052-COM0091

| | |
|---|-----------------|
| Inclusive® 15° Titanium Esthetic Abutment, Posterior* RC..... | 70-1052-COM0091 |
|---|-----------------|

(Esthetic Abutments include SCS Titanium Screw.)

**compatible with: Straumann® Bone Level
Straumann is a registered trademark of Straumann Holding AG.*



Implant components compatible with Straumann® Bone Level

DESCRIPTION (with platform size)

CODE

TITANIUM ESTHETIC ABUTMENTS



Inclusive® Titanium Esthetic Abutment, Anterior* NC70-1052-COM0092
 Inclusive® Titanium Esthetic Abutment, Anterior* RC.....70-1052-COM0093



Inclusive® Titanium Esthetic Abutment, Posterior* RC.....70-1052-COM0094
 (Esthetic Abutments include SCS Titanium Screw.)

TITANIUM ABUTMENT BLANKS



Inclusive® Titanium Abutment Blank* NC70-1052-COM0030
 Inclusive® Titanium Abutment Blank* RC.....70-1052-COM0031
 (Titanium Screw sold separately; please see page 42.)

UCLA PLASTIC ABUTMENTS



Inclusive® UCLA Plastic Abutment* NC70-1052-COM0095
 Inclusive® UCLA Plastic Abutment* RC70-1052-COM0096



Inclusive® UCLA Plastic Abutment, Non-Engaging* NC70-1052-COM0097
 Inclusive® UCLA Plastic Abutment, Non-Engaging* RC70-1052-COM0098
 (UCLA Abutments include SCS Titanium Screw and SCS Guide Pin.)

SCS TITANIUM SCREWS AND GUIDE PINS



Inclusive® Titanium Screw* NC.....70-1052-COM0064
 Inclusive® Titanium Screw (5-pack)* NC70-1052-COM0020



Inclusive® Titanium Screw* RC.....70-1052-COM0065
 Inclusive® Titanium Screw (5-pack)* RC70-1052-COM0021



Inclusive® Guide Pin (5-pack)* NC.....70-1052-COM0059
 Inclusive® Guide Pin (5-pack)* RC.....70-1052-COM0061
 (SCS driver required.)

*compatible with: Straumann® Bone Level
 Straumann is a registered trademark of Straumann Holding AG.



Implant components compatible with Straumann® Bone Level

DESCRIPTION (with platform size)

CODE

MULTI-UNIT ABUTMENTS



Inclusive® Multi-Unit Abutment 1.5 mmH* NC 70-1052-COM0074
 Inclusive® Multi-Unit Abutment 2.5 mmH* NC 70-1052-COM0075
 Inclusive® Multi-Unit Abutment 3.5 mmH* NC 70-1052-COM0076

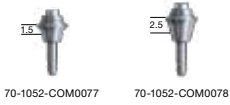

Inclusive® Multi-Unit Abutment 1.5 mmH* RC 70-1052-COM0077
 Inclusive® Multi-Unit Abutment 2.5 mmH* RC 70-1052-COM0078



Inclusive® Multi-Unit Abutment 3.5 mmH* RC 70-1052-COM0079
 Inclusive® Multi-Unit Abutment 4.5 mmH* RC 70-1052-COM0080
(Prosthetic Screw sold separately; please see page 10.)



Inclusive® 17° Multi-Unit Abutment 2.5 mmH* NC 70-1052-COM0081
 Inclusive® 17° Multi-Unit Abutment 3.5 mmH* NC 70-1052-COM0082

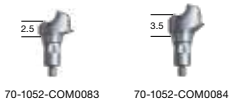

Inclusive® 17° Multi-Unit Abutment 2.5 mmH* RC 70-1052-COM0083
 Inclusive® 17° Multi-Unit Abutment 3.5 mmH* RC 70-1052-COM0084

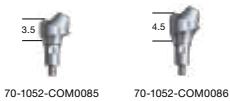

Inclusive® 30° Multi-Unit Abutment 3.5 mmH* RC 70-1052-COM0085
 Inclusive® 30° Multi-Unit Abutment 4.5 mmH* RC 70-1052-COM0086
(Angled Multi-Unit Abutments include Angled Abutment Screw. Prosthetic Screw sold separately; please see page 10.)



MULTI-UNIT TITANIUM SCREWS

Inclusive® Angled Multi-Unit Abutment Screw* NC/RC 70-1052-COM0087

MULTI-UNIT ABUTMENT ACCESSORIES

For a complete line of Multi-Unit Abutment Accessories, please see page 10.

*compatible with: Straumann® Bone Level
 Straumann is a registered trademark of Straumann Holding AG.



Implant components compatible with Straumann® Tissue Level

DESCRIPTION (with platform size)

CODE

IMPLANT ANALOGS



Inclusive® Implant Analog (5-pack)* NN..... 70-1053-COM0006



Inclusive® Implant Analog (5-pack)* RN synOcta®..... 70-1053-COM0007



Inclusive® Implant Analog (5-pack)* WN synOcta® 70-1053-COM0008

TITANIUM SCAN BODIES



Inclusive® Titanium Scan Body* RN synOcta®..... 70-1053-COM0095



Inclusive® Titanium Scan Body* WN synOcta®..... 70-1053-COM0096
(Scan Body includes captured screw.)

TITANIUM ABUTMENTS

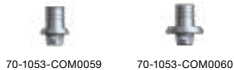

Inclusive® Titanium Abutment 4.5 mmH* RN synOcta®..... 70-1053-COM0059

Inclusive® Titanium Abutment 4.5 mmH* WN synOcta® 70-1053-COM0060

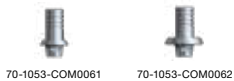

Inclusive® Titanium Abutment 6 mmH* RN synOcta®..... 70-1053-COM0061

Inclusive® Titanium Abutment 6 mmH* WN synOcta® 70-1053-COM0062



Inclusive® Titanium Abutment 4.5 mmH, Non-Engaging* RN synOcta® 70-1053-COM0057

Inclusive® Titanium Abutment 4.5 mmH, Non-Engaging* WN synOcta® 70-1053-COM0058

(SCS Titanium Screw sold separately; please see below.)

SCS TITANIUM SCREWS



Inclusive® Titanium Occlusal Screw* NN 70-1053-COM0035

Inclusive® Titanium Occlusal Screw (5-pack)* NN..... 70-1053-COM0036



Inclusive® Titanium Basal Screw* RN/WN synOcta® 70-1053-COM0034

Inclusive® Titanium Basal Screw (5-pack)* RN/WN synOcta® 70-1053-COM0009

(SCS driver required.)

**compatible with: Straumann® Tissue Level*

Straumann and synOcta are registered trademarks of Straumann Holding AG.



Implant components compatible with Zimmer Dental Screw-Vent®

DESCRIPTION (with platform size)

CODE

IMPLANT ANALOGS



| | |
|---|-----------------|
| Inclusive® Implant Analog (5-pack)* 3.5 mm..... | 70-1054-COM0010 |
| Inclusive® Implant Analog (5-pack)* 4.5 mm..... | 70-1054-COM0011 |
| Inclusive® Implant Analog (5-pack)* 5.7 mm..... | 70-1054-COM0012 |



TITANIUM SCAN BODIES

| | |
|--|-----------------|
| Inclusive® Titanium Scan Body* 3.5 mm..... | 70-1054-COM0160 |
| Inclusive® Titanium Scan Body* 4.5 mm..... | 70-1054-COM0161 |
| Inclusive® Titanium Scan Body* 5.7 mm..... | 70-1054-COM0162 |

(Scan Body includes captured screw.)



BITE VERIFICATION CYLINDERS

| | |
|--|-----------------|
| Inclusive® Bite Verification Cylinder* 3.5 mm..... | 70-1054-COM0097 |
| Inclusive® Bite Verification Cylinder* 4.5 mm..... | 70-1054-COM0098 |
| Inclusive® Bite Verification Cylinder* 5.7 mm..... | 70-1054-COM0099 |



| | |
|---|-----------------|
| Inclusive® Bite Verification Cylinder, Non-Engaging* 3.5 mm | 70-1054-COM0094 |
| Inclusive® Bite Verification Cylinder, Non-Engaging* 4.5 mm | 70-1054-COM0095 |
| Inclusive® Bite Verification Cylinder, Non-Engaging* 5.7 mm | 70-1054-COM0096 |

(Bite Verification Cylinders include Titanium Screw and Guide Pin.)



TITANIUM ABUTMENTS

| | |
|---|-----------------|
| Inclusive® Titanium Abutment 4.5 mmH* 3.5 mm..... | 70-1054-COM0063 |
| Inclusive® Titanium Abutment 4.5 mmH* 4.5 mm..... | 70-1054-COM0065 |
| Inclusive® Titanium Abutment 4.5 mmH* 5.7 mm..... | 70-1054-COM0067 |



| | |
|---|-----------------|
| Inclusive® Titanium Abutment 6 mmH* 3.5 mm..... | 70-1054-COM0004 |
| Inclusive® Titanium Abutment 6 mmH* 4.5 mm..... | 70-1054-COM0005 |
| Inclusive® Titanium Abutment 6 mmH* 5.7 mm..... | 70-1054-COM0006 |



| | |
|--|-----------------|
| Inclusive® Titanium Abutment 4.5 mmH, Non-Engaging* 3.5 mm | 70-1054-COM0069 |
| Inclusive® Titanium Abutment 4.5 mmH, Non-Engaging* 4.5 mm | 70-1054-COM0071 |
| Inclusive® Titanium Abutment 4.5 mmH, Non-Engaging* 5.7 mm | 70-1054-COM0073 |

(Titanium Screw sold separately; please see below.)

*compatible with: Zimmer Dental Screw-Vent®

Screw-Vent is a registered trademark of Zimmer Dental Inc.



Implant components compatible with Zimmer Dental Screw-Vent®

DESCRIPTION (with platform size)

CODE

TITANIUM ABUTMENT BLANKS



70-1054-COM0041 70-1054-COM0042 70-1054-COM0043

| | |
|--|-----------------|
| Inclusive® Titanium Abutment Blank* 3.5 mm | 70-1054-COM0041 |
| Inclusive® Titanium Abutment Blank* 4.5 mm | 70-1054-COM0042 |
| Inclusive® Titanium Abutment Blank* 5.7 mm..... | 70-1054-COM0043 |

(Titanium Screw sold separately; please see below.)

UCLA PLASTIC ABUTMENTS



70-1054-COM0100 70-1054-COM0101 70-1054-COM0102

| | |
|--|-----------------|
| Inclusive® UCLA Plastic Abutment* 3.5 mm | 70-1054-COM0100 |
| Inclusive® UCLA Plastic Abutment* 4.5 mm | 70-1054-COM0101 |
| Inclusive® UCLA Plastic Abutment* 5.7 mm | 70-1054-COM0102 |



70-1054-COM0103 70-1054-COM0104 70-1054-COM0105

| | |
|--|-----------------|
| Inclusive® UCLA Plastic Abutment, Non-Engaging* 3.5 mm | 70-1054-COM0103 |
| Inclusive® UCLA Plastic Abutment, Non-Engaging* 4.5 mm | 70-1054-COM0104 |
| Inclusive® UCLA Plastic Abutment, Non-Engaging* 5.7 mm..... | 70-1054-COM0105 |

(UCLA Abutments include Titanium Screw and Guide Pin.)

TITANIUM SCREWS AND GUIDE PINS



70-1054-COM0048
70-1054-COM0022



70-1054-COM0084

| | |
|---|-----------------|
| Inclusive® Titanium Screw* 3.5/4.5/5.7 mm | 70-1054-COM0048 |
| Inclusive® Titanium Screw (5-pack)* 3.5/4.5/5.7 mm..... | 70-1054-COM0022 |

| | |
|---|-----------------|
| Inclusive® Guide Pin (5-pack)* 3.5/4.5/5.7 mm | 70-1054-COM0084 |
|---|-----------------|

**compatible with: Zimmer Dental Screw-Vent®*

Screw-Vent is a registered trademark of Zimmer Dental Inc.

Parts Index

| CODE | DESCRIPTION | PAGE | CODE | DESCRIPTION | PAGE |
|--|----------------------------------|------|--|--|------|
| ANALOGS | | | (Zimmer Dental Screw-Vent®) | | |
| (BIOMET 3i™ Certain®) | | | (Zimmer Dental Screw-Vent®) | | |
| 70-1047-COM0013 | Implant Analog (5/pk) 3.4 mm | 11 | 70-1054-COM0010 | Implant Analog (5/pk) 3.5 mm | 45 |
| 70-1047-COM0014 | Implant Analog (5/pk) 4.1 mm | 11 | 70-1054-COM0011 | Implant Analog (5/pk) 4.5 mm | 45 |
| 70-1047-COM0015 | Implant Analog (5/pk) 5.0 mm | 11 | 70-1054-COM0012 | Implant Analog (5/pk) 5.7 mm | 45 |
| 70-1047-COM0016 | Implant Analog (5/pk) 6.0 mm | 11 | BITE VERIFICATION CYLINDERS | | |
| (CAMLOG® SCREW-LINE) | | | (BIOMET 3i™ Certain®) | | |
| 70-1135-CAM0068 | Implant Analog (5/pk) 3.3 mm | 15 | 70-1047-COM0130 | Bite Verification Cylinder 3.4 mm | 11 |
| 70-1135-CAM0070 | Implant Analog (5/pk) 3.8 mm | 15 | 70-1047-COM0131 | Bite Verification Cylinder 4.1 mm | 11 |
| 70-1135-CAM0072 | Implant Analog (5/pk) 4.3 mm | 15 | 70-1047-COM0132 | Bite Verification Cylinder 5.0 mm | 11 |
| 70-1135-CAM0074 | Implant Analog (5/pk) 5.0 mm | 15 | 70-1047-COM0133 | Bite Verification Cylinder 6.0 mm | 11 |
| 70-1135-CAM0076 | Implant Analog (5/pk) 6.0 mm | 15 | 70-1047-COM0126 | Bite Verification Cylinder, Non-Engag 3.4 mm | 11 |
| (DENTSPLY Implants Ankylos® C/X) | | | 70-1047-COM0127 | Bite Verification Cylinder, Non-Engag 4.1 mm | 11 |
| 70-1139-COM0020 | Implant Analog (5/pk) C/X 3.5 A | 19 | 70-1047-COM0128 | Bite Verification Cylinder, Non-Engag 5.0 mm | 11 |
| 70-1139-COM0021 | Implant Analog (5/pk) C/X 4.5 B | 19 | 70-1047-COM0129 | Bite Verification Cylinder, Non-Engag 6.0 mm | 11 |
| 70-1139-COM0022 | Implant Analog (5/pk) C/X 5.5 C | 19 | (CAMLOG® SCREW-LINE) | | |
| (DENTSPLY Implants ASTRA TECH Implant System®) | | | 70-1135-CAM0042 | Bite Verification Cylinder 3.3 mm | 15 |
| 70-1048-COM0014 | Implant Analog (5/pk) 3.0 | 21 | 70-1135-CAM0044 | Bite Verification Cylinder 3.8 mm | 15 |
| 70-1048-COM0016 | Implant Analog (5/pk) 3.5/4.0 | 21 | 70-1135-CAM0046 | Bite Verification Cylinder 4.3 mm | 15 |
| 70-1048-COM0019 | Implant Analog (5/pk) 4.5/5.0 | 21 | 70-1135-CAM0048 | Bite Verification Cylinder 5.0 mm | 15 |
| (DENTSPLY Implants ASTRA TECH Implant System® EV) | | | 70-1135-CAM0050 | Bite Verification Cylinder 6.0 mm | 15 |
| 70-1176-COM0249 | Implant Analog 3.0 | 24 | 70-1135-CAM0052 | Bite Verification Cylinder, Non-Engag 3.3 mm | 15 |
| 70-1176-COM0250 | Implant Analog 3.6 | 24 | 70-1135-CAM0054 | Bite Verification Cylinder, Non-Engag 3.8 mm | 15 |
| 70-1176-COM0251 | Implant Analog 4.2 | 24 | 70-1135-CAM0056 | Bite Verification Cylinder, Non-Engag 4.3 mm | 15 |
| 70-1176-COM0252 | Implant Analog 4.8 | 24 | 70-1135-CAM0058 | Bite Verification Cylinder, Non-Engag 5.0 mm | 15 |
| 70-1176-COM0253 | Implant Analog 5.4 | 24 | 70-1135-CAM0060 | Bite Verification Cylinder, Non-Engag 6.0 mm | 15 |
| (Hiossen® HG System) | | | (DENTSPLY Implants Ankylos® C/X) | | |
| 70-1147-COM0017 | Implant Analog Standard | 26 | 70-1139-COM0049 | Bite Verification Cylinder /X | 20 |
| 70-1147-COM0016 | Implant Analog Mini | 26 | 70-1139-COM0048 | Bite Verification Cylinder, Non-Engag C/ | 19 |
| (Inclusive® Tapered Implant System) | | | (DENTSPLY Implants ASTRA TECH Implant System®) | | |
| 70-1072-PRC0055 | Implant Analog 3.0 mmP | 5 | 70-1048-COM0133 | Bite Verification Cylinder 3.0 | 21 |
| 70-1072-PRC0015 | Implant Analog 3.5 mmP | 5 | 70-1048-COM0134 | Bite Verification Cylinder 3.5/4.0 | 21 |
| 70-1072-PRC0017 | Implant Analog 4.5 mmP | 5 | 70-1048-COM0135 | Bite Verification Cylinder 4.5/5.0 | 21 |
| (MegaGen AnyRidge® Implant System) | | | 70-1048-COM0131 | Bite Verification Cylinder, Non-Engag 3.5/4.0 | 21 |
| 70-1173-COM0002 | Implant Analog | 29 | 70-1048-COM0132 | Bite Verification Cylinder, Non-Engag 4.5/5.0 | 21 |
| (Nobel Biocare Brånemark System®) | | | (DENTSPLY Implants ASTRA TECH Implant System® EV) | | |
| 70-1049-COM0006 | Implant Analog (5/pk) RP | 32 | 70-1176-COM0298 | Bite Verification Cylinder 3.0 | 24 |
| (NobelActive®) | | | 70-1176-COM0299 | Bite Verification Cylinder 3.6 | 24 |
| 70-1050-COM0001 | Implant Analog (5/pk) NP | 34 | 70-1176-COM0300 | Bite Verification Cylinder 4.2 | 24 |
| 70-1050-COM0002 | Implant Analog (5/pk) RP | 34 | 70-1176-COM0301 | Bite Verification Cylinder 4.8 | 24 |
| (NobelReplace®) | | | 70-1176-COM0302 | Bite Verification Cylinder 5.4 | 24 |
| 70-1051-COM0002 | Implant Analog (5/pk) NP | 37 | 70-1176-COM0293 | Bite Verification Cylinder, Non-Engag 3.0 | 24 |
| 70-1051-COM0003 | Implant Analog (5/pk) RP | 37 | 70-1176-COM0294 | Bite Verification Cylinder, Non-Engag 3.6 | 24 |
| 70-1051-COM0004 | Implant Analog (5/pk) WP | 37 | 70-1176-COM0295 | Bite Verification Cylinder, Non-Engag 4.2 | 24 |
| 70-1051-COM0001 | Implant Analog (5/pk) 6.0 | 37 | 70-1176-COM0296 | Bite Verification Cylinder, Non-Engag 4.8 | 24 |
| (Straumann® Bone Level) | | | 70-1176-COM0297 | Bite Verification Cylinder, Non-Engag 5.4 | 24 |
| 70-1052-COM0007 | Implant Analog (5/pk) NC | 41 | (Hiossen® HG System) | | |
| 70-1052-COM0008 | Implant Analog (5/pk) RC | 41 | 70-1147-COM0062 | Bite Verification Cylinder Standard | 26 |
| (Straumann® Tissue Level) | | | 70-1147-COM0063 | Bite Verification Cylinder Mini | 26 |
| 70-1053-COM0006 | Implant Analog (5/pk) NN | 44 | 70-1147-COM0060 | Bite Verification Cylinder, Non-Engag Standard | 26 |
| 70-1053-COM0007 | Implant Analog (5/pk) RN synOcta | 44 | 70-1147-COM0061 | Bite Verification Cylinder, Non-Engag Mini | 26 |
| 70-1053-COM0008 | Implant Analog (5/pk) WN synOcta | 44 | | | |

Parts Index

| CODE | DESCRIPTION | PAGE | CODE | DESCRIPTION | PAGE |
|--|---|------|---|---|------|
| (MegaGen AnyRidge® Implant System) | | | 70-1051-COM0238 | Transfer Coping, Open-Tray, NP | 37 |
| 70-1173-COM0015 | Bite Verification Cylinder | 29 | 70-1051-COM0239 | Transfer Coping, Open-Tray, RP | 37 |
| 70-1173-COM0014 | Bite Verification Cylinder, Non-Engag | 29 | 70-1051-COM0240 | Transfer Coping, Open-Tray, WP | 37 |
| (Nobel Biocare Brånemark System®) | | | MULTI-UNIT ABUTMENTS | | |
| 70-1049-COM0047 | Bite Verification Cylinder RP | 32 | (BIOMET 3i™ Certain®) | | |
| 70-1049-COM0044 | Bite Verification Cylinder, Non-Engag RP | 32 | 70-1047-COM0152 | Angled Multi-Unit Abutment Screw 3.4/4.1/5.0/6.0 mm | 14 |
| (NobelActive®) | | | 70-1047-COM0134 | Multi-Unit Abutment 1 mmH 3.4 mm | 14 |
| 70-1050-COM0072 | Bite Verification Cylinder NP | 34 | 70-1047-COM0137 | Multi-Unit Abutment 1 mmH 4.1 mm | 14 |
| 70-1050-COM0073 | Bite Verification Cylinder RP | 34 | 70-1047-COM0141 | Multi-Unit Abutment 1 mmH 5.0 mm | 14 |
| 70-1050-COM0070 | Bite Verification Cylinder, Non-Engag NP | 34 | 70-1047-COM0135 | Multi-Unit Abutment 2 mmH 3.4 mm | 14 |
| 70-1050-COM0071 | Bite Verification Cylinder, Non-Engag RP | 34 | 70-1047-COM0138 | Multi-Unit Abutment 2 mmH 4.1 mm | 14 |
| (NobelReplace®) | | | 70-1047-COM0142 | Multi-Unit Abutment 2 mmH 5.0 mm | 14 |
| 70-1051-COM0167 | Bite Verification Cylinder NP | 37 | 70-1047-COM0136 | Multi-Unit Abutment 3 mmH 3.4 mm | 14 |
| 70-1051-COM0168 | Bite Verification Cylinder RP | 37 | 70-1047-COM0139 | Multi-Unit Abutment 3 mmH 4.1 mm | 14 |
| 70-1051-COM0169 | Bite Verification Cylinder WP | 37 | 70-1047-COM0143 | Multi-Unit Abutment 3 mmH 5.0 mm | 14 |
| 70-1051-COM0170 | Bite Verification Cylinder 6.0 | 37 | 70-1047-COM0140 | Multi-Unit Abutment 5 mmH 4.1 mm | 14 |
| 70-1051-COM0163 | Bite Verification Cylinder, Non-Engag NP | 37 | 70-1047-COM0144 | 17° Multi-Unit Abutment 2 mmH 3.4 mm | 14 |
| 70-1051-COM0164 | Bite Verification Cylinder, Non-Engag RP | 37 | 70-1047-COM0146 | 17° Multi-Unit Abutment 2 mmH 4.1 mm | 14 |
| 70-1051-COM0165 | Bite Verification Cylinder, Non-Engag WP | 38 | 70-1047-COM0148 | 17° Multi-Unit Abutment 2 mmH 5.0 mm | 14 |
| 70-1051-COM0166 | Bite Verification Cylinder, Non-Engag 6.0 | 38 | 70-1047-COM0145 | 17° Multi-Unit Abutment 3 mmH 3.4 mm | 14 |
| (Straumann® Bone Level) | | | 70-1047-COM0147 | 17° Multi-Unit Abutment 3 mmH 4.1 mm | 14 |
| 70-1052-COM0072 | Bite Verification Cylinder NC | 41 | 70-1047-COM0149 | 17° Multi-Unit Abutment 3 mmH 5.0 mm | 14 |
| 70-1052-COM0073 | Bite Verification Cylinder RC | 41 | 70-1047-COM0150 | 30° Multi-Unit Abutment 4 mmH 4.1 mm | 14 |
| 70-1052-COM0070 | Bite Verification Cylinder, Non-Engag NC | 41 | 70-1047-COM0151 | 30° Multi-Unit Abutment 5 mmH 4.1 mm | 14 |
| 70-1052-COM0071 | Bite Verification Cylinder, Non-Engag RC | 41 | (CAMLOG® SCREW-LINE) | | |
| (Zimmer Dental Screw-Vent®) | | | 70-1135-CAM0147 | Angled Multi-Unit Abutment Screw 3.8/4.3 mm | 18 |
| 70-1054-COM0097 | Bite Verification Cylinder 3.5 mm | 45 | 70-1135-CAM0128 | Multi-Unit Abutment 1 mmH 3.8 mm | 18 |
| 70-1054-COM0098 | Bite Verification Cylinder 4.5 mm | 45 | 70-1135-CAM0131 | Multi-Unit Abutment 1 mmH 4.3 mm | 18 |
| 70-1054-COM0099 | Bite Verification Cylinder 5.7 mm | 45 | 70-1135-CAM0135 | Multi-Unit Abutment 1 mmH 5.0 mm | 18 |
| 70-1054-COM0094 | Bite Verification Cylinder, Non-Engag 3.5 mm | 45 | 70-1135-CAM0129 | Multi-Unit Abutment 2 mmH 3.8 mm | 18 |
| 70-1054-COM0095 | Bite Verification Cylinder, Non-Engag 4.5 mm | 45 | 70-1135-CAM0132 | Multi-Unit Abutment 2 mmH 4.3 mm | 18 |
| 70-1054-COM0096 | Bite Verification Cylinder, Non-Engag 5.7 mm | 45 | 70-1135-CAM0136 | Multi-Unit Abutment 2 mmH 5.0 mm | 18 |
| IMPRESSION TRANSFERS | | | 70-1135-CAM0130 | Multi-Unit Abutment 3 mmH 3.8 mm | 18 |
| (Inclusive® Tapered Implant System) | | | 70-1135-CAM0133 | Multi-Unit Abutment 3 mmH 4.3 mm | 18 |
| 70-1072-PRC0051 | Transfer Coping, Closed-Tray, 3.0 mmP x 3.2 mmD | 5 | 70-1135-CAM0137 | Multi-Unit Abutment 3 mmH 5.0 mm | 18 |
| 70-1072-PRC0053 | Transfer Coping, Closed-Tray, 3.0 mmP x 3.7 mmD | 5 | 70-1135-CAM0134 | Multi-Unit Abutment 5 mmH 4.3 mm | 18 |
| 70-1072-PRC0007 | Transfer Coping, Closed-Tray, 3.5 mmP x 3.5 mmD | 5 | 70-1135-CAM0138 | 17° Multi-Unit Abutment 2 mmH 3.8 mm | 18 |
| 70-1072-PRC0009 | Transfer Coping, Closed-Tray, 3.5 mmP x 4.7 mmD | 5 | 70-1135-CAM0140 | 17° Multi-Unit Abutment 2 mmH 4.3 mm | 18 |
| 70-1072-PRC0011 | Transfer Coping, Closed-Tray, 4.5 mmP x 4.5 mmD | 5 | 70-1135-CAM0139 | 17° Multi-Unit Abutment 3 mmH 3.8 mm | 18 |
| 70-1072-PRC0013 | Transfer Coping, Closed-Tray, 4.5 mmP x 5.7 mmD | 5 | 70-1135-CAM0141 | 17° Multi-Unit Abutment 3 mmH 4.3 mm | 18 |
| 70-1072-PRC0052 | Transfer Coping, Open-Tray, 3.0 mmP x 3.2 mmD | 5 | 70-1135-CAM0142 | 17° Multi-Unit Abutment 5 mmH 4.3 mm | 18 |
| 70-1072-PRC0054 | Transfer Coping, Open-Tray, 3.0 mmP x 3.7 mmD | 5 | 70-1135-CAM0143 | 30° Multi-Unit Abutment 3 mmH 3.8 mm | 18 |
| 70-1072-PRC0006 | Transfer Coping, Open-Tray, 3.5 mmP x 3.5 mmD | 5 | 70-1135-CAM0145 | 30° Multi-Unit Abutment 3 mmH 4.3 mm | 18 |
| 70-1072-PRC0008 | Transfer Coping, Open-Tray, 3.5 mmP x 4.7 mmD | 5 | 70-1135-CAM0144 | 30° Multi-Unit Abutment 5 mmH 3.8 mm | 18 |
| 70-1072-PRC0010 | Transfer Coping, Open-Tray, 4.5 mmP x 4.5 mmD | 5 | 70-1135-CAM0146 | 30° Multi-Unit Abutment 5 mmH 4.3 mm | 18 |
| 70-1072-PRC0012 | Transfer Coping, Open-Tray, 4.5 mmP x 5.7 mmD | 5 | (DENTSPLY Implants Ankylos® C/X) | | |
| (NobelReplace®) | | | 70-1139-COM0001 | Multi-Unit Abutment 1.5 mmH /X | 20 |
| 70-1051-COM0235 | Transfer Coping, Closed-Tray, NP | 37 | 70-1139-COM0002 | Multi-Unit Abutment 2.5 mmH /X | 20 |
| 70-1051-COM0236 | Transfer Coping, Closed-Tray, RP | 37 | 70-1139-COM0003 | Multi-Unit Abutment 3.5 mmH /X | 20 |
| 70-1051-COM0237 | Transfer Coping, Closed-Tray, WP | 37 | 70-1139-COM0004 | Multi-Unit Abutment 4.5 mmH /X | 20 |

Parts Index

| CODE | DESCRIPTION | PAGE | CODE | DESCRIPTION | PAGE |
|---|--|------|--|--|------|
| (DENTSPLY Implants ASTRA TECH Implant System®) | | | 70-1074-PRS0005.....17° Multi-Unit Abutment 4.5 mmP x 5 mmH..... 9 | | |
| 70-1048-COM0151 |Angled Multi-Unit Abutment Screw 3.5/4.0 | 23 | 70-1074-PRS0006 |30° Multi-Unit Abutment 3.5 mmP x 3 mmH | 9 |
| 70-1048-COM0152 |Angled Multi-Unit Abutment Screw 4.5/5.0 | 23 | 70-1074-PRS0007 |30° Multi-Unit Abutment 4.5 mmP x 3 mmH | 9 |
| 70-1048-COM0136 |Multi-Unit Abutment 1.5 mmH 3.5/4.0 | 23 | 70-1074-PRS0008 |30° Multi-Unit Abutment 4.5 mmP x 5 mmH | 9 |
| 70-1048-COM0139 |Multi-Unit Abutment 1.5 mmH 4.5/5.0 | 23 | (MegaGen AnyRidge® Implant System) | | |
| 70-1048-COM0137 |Multi-Unit Abutment 2.5 mmH 3.5/4.0 | 23 | 70-1173-COM0034 |Angled Multi-Unit Abutment Screw | 31 |
| 70-1048-COM0140 |Multi-Unit Abutment 2.5 mmH 4.5/5.0 | 23 | 70-1173-COM0023 |Multi-Unit Abutment 2 mmH | 30 |
| 70-1048-COM0138 |Multi-Unit Abutment 3.5 mmH 3.5/4.0 | 23 | 70-1173-COM0024 |Multi-Unit Abutment 3 mmH | 30 |
| 70-1048-COM0141 |Multi-Unit Abutment 3.5 mmH 4.5/5.0 | 23 | 70-1173-COM0025 |Multi-Unit Abutment 4 mmH | 30 |
| 70-1048-COM0142 |Multi-Unit Abutment 4.5 mmH 4.5/5.0 | 23 | 70-1173-COM0026 |Multi-Unit Abutment 5 mmH | 30 |
| 70-1048-COM0143 |17° Multi-Unit Abutment 2.5 mmH 3.5/4.0 | 23 | 70-1173-COM0027 |17° Multi-Unit Abutment 3.5 mmH | 31 |
| 70-1048-COM0145 |17° Multi-Unit Abutment 2.5 mmH 4.5/5.0 | 23 | 70-1173-COM0028 |17° Multi-Unit Abutment 4.5 mmH | 31 |
| 70-1048-COM0144 |17° Multi-Unit Abutment 3.5 mmH 3.5/4.0 | 23 | 70-1173-COM0029 |17° Multi-Unit Abutment 5.5 mmH | 31 |
| 70-1048-COM0146 |17° Multi-Unit Abutment 3.5 mmH 4.5/5.0 | 23 | 70-1173-COM0030 |30° Multi-Unit Abutment 3.5 mmH | 31 |
| 70-1048-COM0147 |30° Multi-Unit Abutment 3.5 mmH 3.5/4.0 | 23 | 70-1173-COM0031 |30° Multi-Unit Abutment 4.5 mmH | 31 |
| 70-1048-COM0149 |30° Multi-Unit Abutment 3.5 mmH 4.5/5.0 | 23 | 70-1173-COM0032 |30° Multi-Unit Abutment 5.5 mmH | 31 |
| 70-1048-COM0148 |30° Multi-Unit Abutment 4.5 mmH 3.5/4.0 | 23 | 70-1173-COM0033 |30° Multi-Unit Abutment 6.5 mmH | 31 |
| 70-1048-COM0150 |30° Multi-Unit Abutment 4.5 mmH 4.5/5.0 | 23 | (Nobel Biocare Brånemark System®) | | |
| (Hiossen® HG System) | | | 70-1049-COM0058 |Angled Multi-Unit Abutment Screw RP | 33 |
| 70-1147-COM0064 |Multi-Unit Abutment 1.5 mmH Standard | 28 | 70-1049-COM0049 |Multi-Unit Abutment 1 mmH RP | 33 |
| 70-1147-COM0065 |Multi-Unit Abutment 1.5 mmH Mini | 28 | 70-1049-COM0050 |Multi-Unit Abutment 2 mmH RP | 33 |
| 70-1147-COM0066 |Multi-Unit Abutment 2.5 mmH Standard | 28 | 70-1049-COM0051 |Multi-Unit Abutment 3 mmH RP | 33 |
| 70-1147-COM0067 |Multi-Unit Abutment 2.5 mmH Mini | 28 | 70-1049-COM0052 |Multi-Unit Abutment 5 mmH RP | 33 |
| 70-1147-COM0068 |Multi-Unit Abutment 3.5 mmH Standard | 28 | 70-1049-COM0053 |17° Multi-Unit Abutment 2 mmH RP | 33 |
| 70-1147-COM0069 |Multi-Unit Abutment 3.5 mmH Mini | 28 | 70-1049-COM0054 |17° Multi-Unit Abutment 3 mmH RP | 33 |
| 70-1147-COM0070 |Multi-Unit Abutment 4.5 mmH Standard | 28 | 70-1049-COM0055 |17° Multi-Unit Abutment 4 mmH RP | 33 |
| 70-1147-COM0071 |17° Multi-Unit Abutment 2.5 mmH Standard | 28 | 70-1049-COM0056 |30° Multi-Unit Abutment 4 mmH RP | 33 |
| 70-1147-COM0079 |Angled Multi-Unit Abutment Screw Standard | 28 | 70-1049-COM0057 |30° Multi-Unit Abutment 5 mmH RP | 33 |
| 70-1147-COM0072 |17° Multi-Unit Abutment 2.5 mmH Mini | 28 | (NobelActive®) | | |
| 70-1147-COM0073 |17° Multi-Unit Abutment 3.5 mmH Standard | 28 | 70-1050-COM0089 |Angled Multi-Unit Abutment Screw NP | 36 |
| 70-1147-COM0074 |17° Multi-Unit Abutment 3.5 mmH Mini | 28 | 70-1050-COM0074 |Multi-Unit Abutment 1.5 mmH NP | 36 |
| 70-1147-COM0075 |30° Multi-Unit Abutment 3.5 mmH Standard | 28 | 70-1050-COM0075 |Multi-Unit Abutment 2.5 mmH NP | 36 |
| 70-1147-COM0076 |30° Multi-Unit Abutment 3.5 mmH Mini | 28 | 70-1050-COM0076 |Multi-Unit Abutment 3.5 mmH NP | 36 |
| 70-1147-COM0077 |30° Multi-Unit Abutment 4.5 mmH Standard | 28 | 70-1050-COM0077 |Multi-Unit Abutment 1.5 mmH RP | 36 |
| 70-1147-COM0078 |30° Multi-Unit Abutment 4.5 mmH Mini | 28 | 70-1050-COM0078 |Multi-Unit Abutment 2.5 mmH RP | 36 |
| 70-1147-COM0080 |Angled Multi-Unit Abutment Screw Mini | 28 | 70-1050-COM0079 |Multi-Unit Abutment 3.5 mmH RP | 36 |
| (Inclusive® Tapered Implant System) | | | 70-1050-COM0080 |Multi-Unit Abutment 4.5 mmH RP | 36 |
| 70-1074-PRS0031 |Angled Multi-Unit Abutment Screw | 9 | 70-1050-COM0081 |17° Multi-Unit Abutment 2.5 mmH NP | 36 |
| 70-1074-PRS0040 |Multi-Unit Abutment 3.0 mmP x 1.5 mmH | 8 | 70-1050-COM0090 |Angled Multi-Unit Abutment Screw RP | 36 |
| 70-1074-PRS0041 |Multi-Unit Abutment 3.0 mmP x 2.5 mmH | 8 | 70-1050-COM0082 |17° Multi-Unit Abutment 3.5 mmH NP | 36 |
| 70-1074-PRS0042 |Multi-Unit Abutment 3.0 mmP x 3.5 mmH | 8 | 70-1050-COM0083 |17° Multi-Unit Abutment 2.5 mmH RP | 36 |
| 70-1074-PRS0009 |Multi-Unit Abutment 3.5 mmP x 1 mmH | 8 | 70-1050-COM0084 |17° Multi-Unit Abutment 3.5 mmH RP | 36 |
| 70-1074-PRS0010 |Multi-Unit Abutment 3.5 mmP x 2 mmH | 8 | 70-1050-COM0085 |30° Multi-Unit Abutment 3.5 mmH NP | 36 |
| 70-1074-PRS0011 |Multi-Unit Abutment 4.5 mmP x 1 mmH | 8 | 70-1050-COM0086 |30° Multi-Unit Abutment 4.5 mmH NP | 36 |
| 70-1074-PRS0012 |Multi-Unit Abutment 4.5 mmP x 2 mmH | 8 | 70-1050-COM0087 |30° Multi-Unit Abutment 3.5 mmH RP | 36 |
| 70-1074-PRS0013 |Multi-Unit Abutment 4.5 mmP x 3 mmH | 8 | 70-1050-COM0088 |30° Multi-Unit Abutment 4.5 mmH RP | 36 |
| 70-1074-PRS0014 |Multi-Unit Abutment 4.5 mmP x 5 mmH | 8 | (NobelReplace®) | | |
| 70-1074-PRS0001 |17° Multi-Unit Abutment 3.5 mmP x 2 mmH | 9 | 70-1051-COM0188 |Angled Multi-Unit Abutment Screw NP | 40 |
| 70-1074-PRS0002 |17° Multi-Unit Abutment 3.5 mmP x 3 mmH | 9 | 70-1051-COM0189 |Angled Multi-Unit Abutment Screw RP | 40 |
| 70-1074-PRS0003 |17° Multi-Unit Abutment 4.5 mmP x 2 mmH | 9 | 70-1051-COM0171 |Multi-Unit Abutment 1 mmH NP | 40 |
| 70-1074-PRS0004 |17° Multi-Unit Abutment 4.5 mmP x 3 mmH | 9 | 70-1051-COM0172 |Multi-Unit Abutment 2 mmH NP | 40 |

Parts Index

| CODE | DESCRIPTION | PAGE | CODE | DESCRIPTION | PAGE |
|--|---|------|--|--|------|
| 70-1051-COM0173 | Multi-Unit Abutment 3 mmH NP | 40 | 70-1074-PRSO053 | Multi-Unit Impression Coping, Open-Tray .048" Hex | 10 |
| 70-1051-COM0174 | Multi-Unit Abutment 1 mmH RP | 40 | 70-1074-PRSO052 | Multi-Unit Impression Coping, Open-Tray .050" Hex | 10 |
| 70-1051-COM0175 | Multi-Unit Abutment 2 mmH RP | 40 | 70-1074-PRSO055 | Multi-Unit Impression Coping, Open-Tray 1.0 mm Hex | 10 |
| 70-1051-COM0176 | Multi-Unit Abutment 3 mmH RP | 40 | 70-1074-PRSO054 | Multi-Unit Impression Coping, Open-Tray SCS | 10 |
| 70-1051-COM0177 | Multi-Unit Abutment 5 mmH RP | 40 | 70-1074-PRSO021 | Multi-Unit Impression Coping, Closed-Tray | 10 |
| 70-1051-COM0178 | Multi-Unit Abutment 1 mmH WP | 40 | 70-1074-PRSO057 | Multi-Unit Titanium Temporary - Unigrip | 10 |
| 70-1051-COM0179 | Multi-Unit Abutment 2 mmH WP | 40 | 70-1074-PRSO056 | Multi-Unit Titanium Temporary .048" Hex | 10 |
| 70-1051-COM0180 | Multi-Unit Abutment 3 mmH WP | 40 | 70-1074-PRSO025 | Multi-Unit Titanium Temporary .050" Hex | 10 |
| 70-1051-COM0181 | 17° Multi-Unit Abutment 2 mmH NP | 40 | 70-1074-PRSO059 | Multi-Unit Titanium Temporary 1.0 mm Hex | 10 |
| 70-1051-COM0182 | 17° Multi-Unit Abutment 3 mmH NP | 40 | 70-1074-PRSO058 | Multi-Unit Titanium Temporary SCS | 10 |
| 70-1051-COM0183 | 17° Multi-Unit Abutment 2 mmH RP | 40 | 70-1074-PRSO016 | Multi-Unit Abutment Analog | 10 |
| 70-1051-COM0184 | 17° Multi-Unit Abutment 3 mmH RP | 40 | 70-1074-PRSO028 | Multi-Unit Driver | 10 |
| 70-1051-COM0185 | 17° Multi-Unit Abutment 4 mmH RP | 40 | 70-1047-COM0153 | Multi-Unit Prosthetic Screw .048" Hex | 10 |
| 70-1051-COM0186 | 30° Multi-Unit Abutment 4 mmH RP | 40 | 70-1072-PRC0014 | Multi-Unit Prosthetic Screw .050" Hex | 10 |
| 70-1051-COM0187 | 30° Multi-Unit Abutment 5 mmH RP | 40 | 70-1072-PRC0046 | Multi-Unit Prosthetic Screw 1.0 mm Hex | 10 |
| (Straumann® Bone Level) | | | 70-1052-COM0088 | Multi-Unit Prosthetic Screw SCS | 10 |
| 70-1052-COM0087 | Angled Multi-Unit Abutment Screw NC/RC | 43 | 70-1072-PRC0043 | Multi-Unit Prosthetic Screw - Unigrip | 10 |
| 70-1052-COM0074 | Multi-Unit Abutment 1.5 mmH NC | 43 | 70-1074-PRSO069 | Multi-Unit Plastic Coping - Unigrip | 10 |
| 70-1052-COM0075 | Multi-Unit Abutment 2.5 mmH NC | 43 | 70-1074-PRSO068 | Multi-Unit Plastic Coping .048" Hex | 10 |
| 70-1052-COM0076 | Multi-Unit Abutment 3.5 mmH NC | 43 | 70-1074-PRSO067 | Multi-Unit Plastic Coping .050" Hex | 10 |
| 70-1052-COM0077 | Multi-Unit Abutment 1.5 mmH RC | 43 | 70-1074-PRSO071 | Multi-Unit Plastic Coping 1.0 mm Hex | 10 |
| 70-1052-COM0078 | Multi-Unit Abutment 2.5 mmH RC | 43 | 70-1074-PRSO070 | Multi-Unit Plastic Coping SCS | 10 |
| 70-1052-COM0079 | Multi-Unit Abutment 3.5 mmH RC | 43 | TITANIUM SCAN BODIES | | |
| 70-1052-COM0080 | Multi-Unit Abutment 4.5 mmH RC | 43 | (BIOMET 3i™ Certain®) | | |
| 70-1052-COM0081 | 17° Multi-Unit Abutment 2.5 mmH NC | 43 | 70-1047-COM0209 | Titanium Scan Body 3.4 mm | 11 |
| 70-1052-COM0082 | 17° Multi-Unit Abutment 3.5 mmH NC | 43 | 70-1047-COM0210 | Titanium Scan Body 4.1 mm | 11 |
| 70-1052-COM0083 | 17° Multi-Unit Abutment 2.5 mmH RC | 43 | 70-1047-COM0211 | Titanium Scan Body 5.0 mm | 11 |
| 70-1052-COM0084 | 17° Multi-Unit Abutment 3.5 mmH RC | 43 | 70-1047-COM0212 | Titanium Scan Body 6.0 mm | 11 |
| 70-1052-COM0085 | 30° Multi-Unit Abutment 3.5 mmH RC | 43 | (CAMLOG® SCREW-LINE) | | |
| 70-1052-COM0086 | 30° Multi-Unit Abutment 4.5 mmH RC | 43 | 70-1135-CAM0207 | Titanium Scan Body 3.3 mm | 15 |
| MULTI-UNIT ABUTMENT ACCESSORIES | | | 70-1135-CAM0208 | Titanium Scan Body 3.8 mm | 15 |
| (Inclusive® Tapered Implant System) | | | 70-1135-CAM0209 | Titanium Scan Body 4.3 mm | 15 |
| 70-1074-PRSO044 | Multi-Unit Temporary Healing Cap - Unigrip | 10 | 70-1135-CAM0210 | Titanium Scan Body 5.0 mm | 15 |
| 70-1074-PRSO043 | Multi-Unit Temporary Healing Cap .048" Hex | 10 | 70-1135-CAM0211 | Titanium Scan Body 6.0 mm | 15 |
| 70-1074-PRSO015 | Multi-Unit Temporary Healing Cap .050" Hex | 10 | (DENTSPLY Implants Ankylos® C/X) | | |
| 70-1074-PRSO046 | Multi-Unit Temporary Healing Cap 1.0 mm Hex | 10 | 70-1139-COM0060 | Titanium Scan Body /X | 20 |
| 70-1074-PRSO045 | Multi-Unit Temporary Healing Cap SCS | 10 | (DENTSPLY Implants ASTRA TECH Implant System®) | | |
| 70-1074-PRSO048 | Multi-Unit Coping 4.5 mmH, Non-Engag - Unigrip | 10 | 70-1048-COM0194 | Titanium Scan Body 3.0 | 21 |
| 70-1074-PRSO047 | Multi-Unit Coping 4.5 mmH, Non-Engag .048" Hex | 10 | 70-1048-COM0195 | Titanium Scan Body 3.5/4.0 | 21 |
| 70-1073-PRA0037 | Multi-Unit Coping 4.5 mmH, Non-Engag .050" Hex | 10 | 70-1048-COM0196 | Titanium Scan Body 4.5/5.0 | 21 |
| 70-1074-PRSO050 | Multi-Unit Coping 4.5 mmH, Non-Engag 1.0 mm | 10 | (DENTSPLY Implants ASTRA TECH Implant System® EV) | | |
| 70-1074-PRSO049 | Multi-Unit Coping 4.5 mmH, Non-Engag SCS | 10 | 70-1176-COM0388 | Titanium Scan Body 3.0 | 24 |
| 70-1074-PRSO035 | Multi-Unit Guide Pin .048" Hex | 10 | 70-1176-COM0384 | Titanium Scan Body 3.6 | 24 |
| 70-1074-PRSO061 | Multi-Unit Guide Pin .050" Hex | 10 | 70-1176-COM0385 | Titanium Scan Body 4.2 | 24 |
| 70-1074-PRSO036 | Multi-Unit Guide Pin 1.0 mm Hex | 10 | 70-1176-COM0386 | Titanium Scan Body 4.8 | 24 |
| 70-1074-PRSO037 | Multi-Unit Guide Pin SCS | 10 | 70-1176-COM0387 | Titanium Scan Body 5.4 | 24 |
| 70-1074-PRSO019 | Multi-Unit Guide Pin - Unigrip | 10 | (Hiossen® HG System) | | |
| 70-1074-PRSO030 | Multi-Unit Gold/Plastic Coping | 10 | 70-1147-COM0089 | Titanium Scan Body Standard | 26 |
| 70-1074-PRSO018 | Multi-Unit Gold Bar Coping | 10 | 70-1147-COM0090 | Titanium Scan Body Mini | 26 |
| 70-1074-PRSO022 | Multi-Unit Impression Coping, Open-Tray - Unigrip | 10 | | | |

Parts Index

| CODE | DESCRIPTION | PAGE | CODE | DESCRIPTION | PAGE |
|--|--|------|---|--|------|
| (Inclusive® Tapered Implant System) | | | 70-1135-CAM0119Titanium Abutment Blank 4.3 mm17 | | |
| 70-1073-PRA0080 |Titanium Scan Body 3.0 mmP..... | 6 | 70-1135-CAM0120 |Titanium Abutment Blank 5.0 mm..... | 17 |
| 70-1073-PRA0081 |Titanium Scan Body 3.5 mmP..... | 6 | 70-1135-CAM0121 |Titanium Abutment Blank 6.0 mm17 | 17 |
| 70-1073-PRA0079 |Titanium Scan Body 4.5 mmP..... | 6 | (DENTSPLY Implants Ankylos® C/X) | | |
| (Keystone Dental PrimaConnex®) | | | 70-1139-COM0013 |Titanium Abutment Blank C/X..... | 19 |
| 70-1055-COM0048 |Titanium Scan Body RD..... | 29 | (DENTSPLY Implants ASTRA TECH Implant System®) | | |
| 70-1055-COM0047 |Titanium Scan Body SD..... | 29 | 70-1048-COM0064 |Titanium Abutment Blank 3.0..... | 22 |
| 70-1055-COM0049 |Titanium Scan Body WD..... | 29 | 70-1048-COM0065 |Titanium Abutment Blank 3.5/4.0..... | 22 |
| (MegaGen AnyRidge® Implant System) | | | 70-1048-COM0066 |Titanium Abutment Blank 4.5/5.0..... | 22 |
| 70-1173-COM0051 |Titanium Scan Body..... | 29 | (DENTSPLY Implants ASTRA TECH Implant System® EV) | | |
| (Neoss®) | | | 70-1176-COM0191 |Titanium Abutment Blank 3.0..... | 25 |
| 70-1056-COM0016 |Titanium Scan Body 4.0 mm..... | 31 | 70-1176-COM0192 |Titanium Abutment Blank 3.6..... | 25 |
| (Nobel Biocare Brånemark System®) | | | 70-1176-COM0193 |Titanium Abutment Blank 4.2..... | 25 |
| 70-1049-COM0074 |Titanium Scan Body RP..... | 32 | 70-1176-COM0194 |Titanium Abutment Blank 4.8..... | 25 |
| (NobelActive®) | | | 70-1176-COM0195 |Titanium Abutment Blank 5.4..... | 25 |
| 70-1050-COM0139 |Titanium Scan Body NP..... | 34 | (Hiossen® HG System) | | |
| 70-1050-COM0140 |Titanium Scan Body RP..... | 34 | 70-1147-COM0009 |Titanium Abutment Blank Standard..... | 27 |
| (NobelReplace®) | | | 70-1147-COM0008 |Titanium Abutment Blank Mini..... | 27 |
| 70-1051-COM0267 |Titanium Scan Body NP..... | 37 | (MegaGen AnyRidge® Implant System) | | |
| 70-1051-COM0268 |Titanium Scan Body RP..... | 37 | 70-1173-COM0003 |Titanium Abutment Blank..... | 30 |
| 70-1051-COM0269 |Titanium Scan Body WP..... | 37 | (Nobel Biocare Brånemark System®) | | |
| 70-1051-COM0270 |Titanium Scan Body 6.0..... | 37 | 70-1049-COM0016 |Titanium Abutment Blank RP..... | 32 |
| (Straumann® Bone Level) | | | (NobelActive®) | | |
| 70-1052-COM0139 |Titanium Scan Body NC..... | 41 | 70-1050-COM0029 |Titanium Abutment Blank NP..... | 35 |
| 70-1052-COM0140 |Titanium Scan Body RC..... | 41 | 70-1050-COM0030 |Titanium Abutment Blank RP..... | 35 |
| (Straumann® Tissue Level) | | | (NobelReplace®) | | |
| 70-1053-COM0095 |Titanium Scan Body RN synOcta®..... | 44 | 70-1051-COM0056 |Titanium Abutment Blank NP..... | 39 |
| 70-1053-COM0096 |Titanium Scan Body WN synOcta®..... | 44 | 70-1051-COM0057 |Titanium Abutment Blank RP..... | 39 |
| (Zimmer Dental Screw-Vent®) | | | 70-1051-COM0058 |Titanium Abutment Blank WP..... | 39 |
| 70-1054-COM0160 |Titanium Scan Body 3.5 mm..... | 45 | 70-1051-COM0055 |Titanium Abutment Blank 6.0..... | 39 |
| 70-1054-COM0161 |Titanium Scan Body 4.5 mm..... | 45 | (Straumann® Bone Level) | | |
| 70-1054-COM0162 |Titanium Scan Body 5.7 mm..... | 45 | 70-1052-COM0030 |Titanium Abutment Blank NC..... | 42 |
| TEMPORARY ABUTMENTS | | | 70-1052-COM0031 |Titanium Abutment Blank RC..... | 42 |
| (Inclusive® Tapered Implant System) | | | (Zimmer Dental Screw-Vent®) | | |
| 70-1073-PRA0048 |Temporary Abutment 3.0 mmP..... | 6 | 70-1054-COM0041 |Titanium Abutment Blank 3.5 mm..... | 46 |
| 70-1073-PRA0022 |Temporary Abutment 3.5 mmP..... | 6 | 70-1054-COM0042 |Titanium Abutment Blank 4.5 mm..... | 46 |
| 70-1073-PRA0024 |Temporary Abutment 4.5 mmP..... | 6 | 70-1054-COM0043 |Titanium Abutment Blank 5.7 mm..... | 46 |
| 70-1073-PRA0047 |Temporary Abutment, Non-Engag, 3.0 mmP..... | 6 | TITANIUM ABUTMENTS | | |
| 70-1073-PRA0023 |Temporary Abutment, Non-Engag, 3.5 mmP..... | 6 | (BIOMET 3i™ Certain®) | | |
| 70-1073-PRA0025 |Temporary Abutment, Non-Engag, 4.5 mmP..... | 6 | 70-1047-COM0084 |Titanium Abutment 4.5 mmH 3.4 mm..... | 12 |
| TITANIUM ABUTMENT BLANKS | | | 70-1047-COM0086 |Titanium Abutment 4.5 mmH 4.1 mm..... | 12 |
| (BIOMET 3i™ Certain®) | | | 70-1047-COM0088 |Titanium Abutment 4.5 mmH 5.0 mm..... | 12 |
| 70-1047-COM0054 |Titanium Abutment Blank 3.4 mm..... | 13 | 70-1047-COM0090 |Titanium Abutment 4.5 mmH 6.0 mm..... | 12 |
| 70-1047-COM0055 |Titanium Abutment Blank 4.1 mm..... | 13 | 70-1047-COM0092 |Titanium Abutment 4.5 mmH, Non-Engag, 3.4 mm..... | 12 |
| 70-1047-COM0056 |Titanium Abutment Blank 5.0 mm..... | 13 | 70-1047-COM0094 |Titanium Abutment 4.5 mmH, Non-Engag, 4.1 mm..... | 12 |
| 70-1047-COM0057 |Titanium Abutment Blank 6.0 mm..... | 13 | 70-1047-COM0096 |Titanium Abutment 4.5 mmH, Non-Engag, 5.0 mm..... | 12 |
| (CAMLOG® SCREW-LINE) | | | 70-1047-COM0098 |Titanium Abutment 4.5 mmH, Non-Engag, 6.0 mm..... | 12 |
| 70-1135-CAM0117 |Titanium Abutment Blank 3.3 mm..... | 17 | 70-1047-COM0005 |Titanium Abutment 6 mmH 3.4 mm..... | 12 |
| 70-1135-CAM0118 |Titanium Abutment Blank 3.8 mm..... | 17 | 70-1047-COM0006 |Titanium Abutment 6 mmH 4.1 mm..... | 12 |
| | | | 70-1047-COM0007 |Titanium Abutment 6 mmH 5.0 mm..... | 12 |

Parts Index

| CODE | DESCRIPTION | PAGE | CODE | DESCRIPTION | PAGE |
|--|--|------|--|--|------|
| 70-1047-COM0008 | Titanium Abutment 6 mmH 6.0 mm | 12 | 70-1147-COM0046 | Titanium Abutment 6 mmH Standard | 27 |
| (CAMLOG® SCREW-LINE) | | | 70-1147-COM0047 | Titanium Abutment 6 mmH Mini | 27 |
| 70-1135-CAM0012 | Titanium Abutment 4.5 mmH 3.3 mm | 16 | 70-1147-COM0044 | Titanium Abutment 4.5 mmH, Non-Engag, Standard | 27 |
| 70-1135-CAM0014 | Titanium Abutment 4.5 mmH 3.8 mm | 16 | 70-1147-COM0045 | Titanium Abutment 4.5 mmH, Non-Engag, Mini | 27 |
| 70-1135-CAM0016 | Titanium Abutment 4.5 mmH 4.3 mm | 16 | (Inclusive® Tapered Implant System) | | |
| 70-1135-CAM0018 | Titanium Abutment 4.5 mmH 5.0 mm | 16 | 70-1073-PRA0045 | Titanium Abutment 3.5 mmP x 4.5 mmH | 6 |
| 70-1135-CAM0020 | Titanium Abutment 4.5 mmH 6.0 mm | 16 | 70-1073-PRA0046 | Titanium Abutment 4.5 mmP x 4.5 mmH | 6 |
| 70-1135-CAM0022 | Titanium Abutment 4.5 mmH, Non-Engag, 3.3 mm | 16 | 70-1073-PRA0052 | Titanium Abutment 3.0 mmP x 4.5 mmH | 6 |
| 70-1135-CAM0024 | Titanium Abutment 4.5 mmH, Non-Engag, 3.8 mm | 16 | 70-1073-PRA0053 | Titanium Abutment 3.0 mmP x 6 mmH | 6 |
| 70-1135-CAM0026 | Titanium Abutment 4.5 mmH, Non-Engag, 4.3 mm | 16 | 70-1073-PRA0006 | Titanium Abutment 3.5 mmP x 6 mmH | 6 |
| 70-1135-CAM0028 | Titanium Abutment 4.5 mmH, Non-Engag, 5.0 mm | 16 | 70-1073-PRA0008 | Titanium Abutment 4.5 mmP x 6 mmH | 6 |
| 70-1135-CAM0030 | Titanium Abutment 4.5 mmH, Non-Engag, 6.0 mm | 16 | (MegaGen AnyRidge® Implant System) | | |
| 70-1135-CAM0032 | Titanium Abutment 6 mmH 3.3 mm | 16 | 70-1173-COM0012 | Titanium Abutment 4.5 mmH | 29 |
| 70-1135-CAM0034 | Titanium Abutment 6 mmH 3.8 mm | 16 | 70-1173-COM0013 | Titanium Abutment 6 mmH | 29 |
| 70-1135-CAM0036 | Titanium Abutment 6 mmH 4.3 mm | 16 | 70-1173-COM0010 | Titanium Abutment 4.5 mmH, Non-Engag, Ø3.5 | 29 |
| 70-1135-CAM0038 | Titanium Abutment 6 mmH 5.0 mm | 16 | 70-1173-COM0011 | Titanium Abutment 4.5 mmH, Non-Engag, Ø5.0 | 29 |
| 70-1135-CAM0040 | Titanium Abutment 6 mmH 6.0 mm | 16 | (Nobel Biocare Brånemark System®) | | |
| (DENTSPLY Implants Ankylos® C/X) | | | 70-1049-COM0024 | Titanium Abutment 4.5 mmH RP | 32 |
| 70-1139-COM0045 | Titanium Abutment 4.5 mmH /X 3.5 A | 20 | 70-1049-COM0026 | Titanium Abutment 4.5 mmH, Non-Engag, RP | 32 |
| 70-1139-COM0041 | Titanium Abutment 4.5 mmH, Non-Engag, C/ 3.5 A | 19 | 70-1049-COM0002 | Titanium Abutment 6 mmH RP | 32 |
| 70-1139-COM0042 | Titanium Abutment 4.5 mmH, Non-Engag, C/ 4.5 B | 19 | (NobelActive®) | | |
| 70-1139-COM0043 | Titanium Abutment 4.5 mmH, Non-Engag, C/ 5.5 C | 19 | 70-1050-COM0046 | Titanium Abutment 4.5 mmH NP | 34 |
| 70-1139-COM0046 | Titanium Abutment 4.5 mmH /X 4.5 B | 20 | 70-1050-COM0048 | Titanium Abutment 4.5 mmH RP | 34 |
| (DENTSPLY Implants ASTRA TECH Implant System®) | | | 70-1050-COM0021 | Titanium Abutment 6 mmH NP | 34 |
| 70-1048-COM0089 | Titanium Abutment 4.5 mmH 3.0 | 21 | 70-1050-COM0022 | Titanium Abutment 6 mmH RP | 34 |
| 70-1048-COM0091 | Titanium Abutment 4.5 mmH 3.5/4.0 | 21 | 70-1050-COM0050 | Titanium Abutment 4.5 mmH, Non-Engag, NP | 34 |
| 70-1048-COM0093 | Titanium Abutment 4.5 mmH 4.5/5.0 | 21 | 70-1050-COM0052 | Titanium Abutment 4.5 mmH, Non-Engag, RP | 34 |
| 70-1048-COM0097 | Titanium Abutment 4.5 mmH, Non-Engag, 3.5/4.0 | 21 | (NobelReplace®) | | |
| 70-1048-COM0099 | Titanium Abutment 4.5 mmH, Non-Engag, 4.5/5.0 | 21 | 70-1051-COM0090 | Titanium Abutment 4.5 mmH NP | 38 |
| 70-1048-COM0004 | Titanium Abutment 6 mmH 3.0 | 21 | 70-1051-COM0092 | Titanium Abutment 4.5 mmH RP | 38 |
| 70-1048-COM0005 | Titanium Abutment 6 mmH 3.5/4.0 | 21 | 70-1051-COM0094 | Titanium Abutment 4.5 mmH WP | 38 |
| 70-1048-COM0006 | Titanium Abutment 6 mmH 4.5/5.0 | 21 | 70-1051-COM0088 | Titanium Abutment 4.5 mmH 6.0 | 38 |
| (DENTSPLY Implants ASTRA TECH Implant System® EV) | | | 70-1051-COM0048 | Titanium Abutment 6 mmH NP | 38 |
| 70-1176-COM0283 | Titanium Abutment 4.5 mmH 3.0 | 25 | 70-1051-COM0049 | Titanium Abutment 6 mmH RP | 38 |
| 70-1176-COM0284 | Titanium Abutment 4.5 mmH 3.6 | 25 | 70-1051-COM0050 | Titanium Abutment 6 mmH WP | 38 |
| 70-1176-COM0285 | Titanium Abutment 4.5 mmH 4.2 | 25 | 70-1051-COM0047 | Titanium Abutment 6 mmH 6.0 | 38 |
| 70-1176-COM0286 | Titanium Abutment 4.5 mmH 4.8 | 25 | 70-1051-COM0098 | Titanium Abutment 4.5 mmH, Non-Engag, NP | 38 |
| 70-1176-COM0287 | Titanium Abutment 4.5 mmH 5.4 | 25 | 70-1051-COM0100 | Titanium Abutment 4.5 mmH, Non-Engag, RP | 38 |
| 70-1176-COM0288 | Titanium Abutment 6 mmH 3.0 | 25 | 70-1051-COM0102 | Titanium Abutment 4.5 mmH, Non-Engag, WP | 38 |
| 70-1176-COM0289 | Titanium Abutment 6 mmH 3.6 | 25 | 70-1051-COM0096 | Titanium Abutment 4.5 mmH, Non-Engag, 6.0 | 38 |
| 70-1176-COM0290 | Titanium Abutment 6 mmH 4.2 | 25 | (Straumann® Bone Level) | | |
| 70-1176-COM0291 | Titanium Abutment 6 mmH 4.8 | 25 | 70-1052-COM0045 | Titanium Abutment 4.5 mmH NC | 41 |
| 70-1176-COM0292 | Titanium Abutment 6 mmH 5.4 | 25 | 70-1052-COM0047 | Titanium Abutment 4.5 mmH RC | 41 |
| 70-1176-COM0278 | Titanium Abutment 4.5 mmH, Non-Engag, 3.0 | 25 | 70-1052-COM0003 | Titanium Abutment 6 mmH NC | 41 |
| 70-1176-COM0279 | Titanium Abutment 4.5 mmH, Non-Engag, 3.6 | 25 | 70-1052-COM0004 | Titanium Abutment 6 mmH RC | 41 |
| 70-1176-COM0280 | Titanium Abutment 4.5 mmH, Non-Engag, 4.2 | 25 | 70-1052-COM0049 | Titanium Abutment 4.5 mmH, Non-Engag, NC | 41 |
| 70-1176-COM0281 | Titanium Abutment 4.5 mmH, Non-Engag, 4.8 | 25 | 70-1052-COM0051 | Titanium Abutment 4.5 mmH, Non-Engag, RC | 41 |
| 70-1176-COM0282 | Titanium Abutment 4.5 mmH, Non-Engag, 5.4 | 25 | (Straumann® Tissue Level) | | |
| (Hiossen® HG System) | | | 70-1053-COM0059 | Titanium Abutment 4.5 mmH, RN synOcta | 44 |
| 70-1147-COM0042 | Titanium Abutment 4.5 mmH Standard | 26 | 70-1053-COM0060 | Titanium Abutment 4.5 mmH, WN synOcta | 44 |
| 70-1147-COM0043 | Titanium Abutment 4.5 mmH Mini | 26 | 70-1053-COM0061 | Titanium Abutment 6 mmH, RN synOcta | 44 |

Parts Index

| CODE | DESCRIPTION | PAGE | CODE | DESCRIPTION | PAGE |
|---|--|------|--|---|------|
| 70-1053-COM0062 | Titanium Abutment 6 mmH, WN synOcta | 44 | 70-1048-COM0160 | Ti. Esthetic Abut., Anterior 4.5/5.0 | 22 |
| 70-1053-COM0057 | Titanium Abutment 4.5 mmH, Non-Engag, RN synOcta | 44 | 70-1048-COM0161 | Ti. Esthetic Abut., Posterior 3.5/4.0 | 22 |
| 70-1053-COM0058 | Titanium Abutment 4.5 mmH, Non-Engag, WN synOcta | 44 | 70-1048-COM0162 | Ti. Esthetic Abut., Posterior 4.5/5.0 | 22 |
| (Zimmer Dental Screw-Vent®) | | | (Hiossen® HG System) | | |
| 70-1054-COM0063 | Titanium Abutment 4.5 mmH 3.5 mm | 45 | 70-1147-COM0052 | 15° Ti. Esthetic Abut., Anterior Standard | 27 |
| 70-1054-COM0065 | Titanium Abutment 4.5 mmH 4.5 mm | 45 | 70-1147-COM0053 | 15° Ti. Esthetic Abut., Anterior Mini | 27 |
| 70-1054-COM0067 | Titanium Abutment 4.5 mmH 5.7 mm | 45 | 70-1147-COM0054 | 15° Ti. Esthetic Abut., Posterior Standard | 27 |
| 70-1054-COM0004 | Titanium Abutment 6 mmH 3.5 mm | 45 | 70-1147-COM0055 | 15° Ti. Esthetic Abut., Posterior Mini | 27 |
| 70-1054-COM0005 | Titanium Abutment 6 mmH 4.5 mm | 45 | 70-1147-COM0048 | Ti. Esthetic Abut., Anterior Standard | 27 |
| 70-1054-COM0006 | Titanium Abutment 6 mmH 5.7 mm | 45 | 70-1147-COM0049 | Ti. Esthetic Abut., Anterior Mini | 27 |
| 70-1054-COM0069 | Titanium Abutment 4.5 mmH, Non-Engag, 3.5 mm | 45 | 70-1147-COM0050 | Ti. Esthetic Abut., Posterior Standard | 27 |
| 70-1054-COM0071 | Titanium Abutment 4.5 mmH, Non-Engag, 4.5 mm | 45 | 70-1147-COM0051 | Ti. Esthetic Abut., Posterior Mini | 27 |
| 70-1054-COM0073 | Titanium Abutment 4.5 mmH, Non-Engag, 5.7 mm | 45 | (Inclusive® Tapered Implant System) | | |
| TITANIUM ESTHETIC ABUTMENTS | | | 70-1073-PRA0054 | 15° Ti. Esthetic Abut., Anterior, 3.0 mmP x 1.5 mmH | 7 |
| (BIOMET 3i™ Certain®) | | | 70-1073-PRA0059 | 15° Ti. Esthetic Abut., Anterior, 3.0 mmP x 2.3 mmH | 7 |
| 70-1047-COM0154 | 15° Ti. Esthetic Abut., Anterior 3.4 mm | 12 | 70-1073-PRA0009 | 15° Ti. Esthetic Abut., Anterior, 3.5 mmP | 7 |
| 70-1047-COM0155 | 15° Ti. Esthetic Abut., Anterior 4.1 mm | 12 | 70-1073-PRA0010 | 15° Ti. Esthetic Abut., Anterior, 4.5 mmP | 7 |
| 70-1047-COM0156 | 15° Ti. Esthetic Abut., Anterior 5.0 mm | 12 | 70-1073-PRA0013 | 15° Ti. Esthetic Abut., Posterior, 4.5 mmP | 7 |
| 70-1047-COM0157 | 15° Ti. Esthetic Abut., Posterior 4.1 mm | 12 | 70-1073-PRA0055 | Ti. Esthetic Abut., Anterior 3.0 mmP x 1.5 mmH | 7 |
| 70-1047-COM0158 | 15° Ti. Esthetic Abut., Posterior 5.0 mm | 12 | 70-1073-PRA0060 | Ti. Esthetic Abut., Anterior 3.0 mmP x 2.3 mmH | 7 |
| 70-1047-COM0159 | Ti. Esthetic Abut., Anterior 3.4 mm | 12 | 70-1073-PRA0011 | Ti. Esthetic Abut., Anterior 3.5 mmP | 7 |
| 70-1047-COM0160 | Ti. Esthetic Abut., Anterior 4.1 mm | 12 | 70-1073-PRA0012 | Ti. Esthetic Abut., Anterior 4.5 mmP | 7 |
| 70-1047-COM0161 | Ti. Esthetic Abut., Anterior 5.0 mm | 12 | 70-1073-PRA0014 | Ti. Esthetic Abut., Posterior 4.5 mmP | 7 |
| 70-1047-COM0162 | Ti. Esthetic Abut., Posterior 4.1 mm | 12 | 70-1073-PRA0015 | Ti. Esthetic Abut., Posterior, Wide 4.5 mmP | 7 |
| 70-1047-COM0163 | Ti. Esthetic Abut., Posterior 5.0 mm | 12 | (MegaGen AnyRidge® Implant System) | | |
| 70-1047-COM0164 | Ti. Esthetic Abut., Posterior 6.0 mm | 12 | 70-1173-COM0019 | 15° Ti. Esthetic Abut., Anterior | 30 |
| (CAMLOG® SCREW-LINE) | | | 70-1173-COM0021 | 15° Ti. Esthetic Abut., Posterior | 30 |
| 70-1135-CAM0148 | 15° Ti. Esthetic Abut., Anterior 3.3 mm | 16 | 70-1173-COM0020 | Ti. Esthetic Abut., Anterior | 30 |
| 70-1135-CAM0149 | 15° Ti. Esthetic Abut., Anterior 3.8 mm | 16 | 70-1173-COM0022 | Ti. Esthetic Abut., Anterior | 30 |
| 70-1135-CAM0150 | 15° Ti. Esthetic Abut., Anterior 4.3 mm | 16 | (NobelActive®) | | |
| 70-1135-CAM0151 | 15° Ti. Esthetic Abut., Posterior 4.3 mm | 16 | 70-1050-COM0091 | 15° Ti. Esthetic Abut., Anterior NP | 34 |
| 70-1135-CAM0152 | 15° Ti. Esthetic Abut., Posterior 5.0 mm | 16 | 70-1050-COM0092 | 15° Ti. Esthetic Abut., Anterior RP | 34 |
| 70-1135-CAM0153 | Ti. Esthetic Abut., Anterior 3.3 mm | 17 | 70-1050-COM0093 | 15° Ti. Esthetic Abut., Posterior RP | 34 |
| 70-1135-CAM0154 | Ti. Esthetic Abut., Anterior 3.8 mm | 17 | 70-1050-COM0094 | Ti. Esthetic Abut., Anterior NP | 35 |
| 70-1135-CAM0155 | Ti. Esthetic Abut., Anterior 4.3 mm | 17 | 70-1050-COM0095 | Ti. Esthetic Abut., Anterior RP | 35 |
| 70-1135-CAM0156 | Ti. Esthetic Abut., Posterior 4.3 mm | 17 | 70-1050-COM0096 | Ti. Esthetic Abut., Posterior RP | 35 |
| 70-1135-CAM0157 | Ti. Esthetic Abut., Posterior 5.0 mm | 17 | (NobelReplace®) | | |
| (DENTSPLY Implants Ankylos® C/X) | | | 70-1051-COM0190 | 15° Ti. Esthetic Abut., Anterior NP | 38 |
| 70-1139-COM0052 | 15° Ti. Esthetic Abut., Anterior /X | 20 | 70-1051-COM0191 | 15° Ti. Esthetic Abut., Anterior RP | 38 |
| 70-1139-COM0053 | 15° Ti. Esthetic Abut., Posterior /X | 20 | 70-1051-COM0192 | 15° Ti. Esthetic Abut., Anterior WP | 38 |
| 70-1139-COM0050 | Ti. Esthetic Abut., Anterior /X | 20 | 70-1051-COM0193 | 15° Ti. Esthetic Abut., Posterior RP | 38 |
| 70-1139-COM0051 | Ti. Esthetic Abut., Posterior /X | 20 | 70-1051-COM0194 | 15° Ti. Esthetic Abut., Posterior WP | 38 |
| (DENTSPLY Implants ASTRA TECH Implant System®) | | | 70-1051-COM0195 | Ti. Esthetic Abut., Anterior NP | 38 |
| 70-1048-COM0153 | 15° Ti. Esthetic Abut., Anterior 3.0 | 21 | 70-1051-COM0196 | Ti. Esthetic Abut., Anterior RP | 38 |
| 70-1048-COM0154 | 15° Ti. Esthetic Abut., Anterior 3.5/4.0 | 21 | 70-1051-COM0197 | Ti. Esthetic Abut., Anterior WP | 38 |
| 70-1048-COM0155 | 15° Ti. Esthetic Abut., Anterior 4.5/5.0 | 21 | 70-1051-COM0200 | Ti. Esthetic Abut., Posterior 6.0 | 38 |
| 70-1048-COM0156 | 15° Ti. Esthetic Abut., Posterior 3.5/4.0 | 22 | 70-1051-COM0198 | Ti. Esthetic Abut., Posterior RP | 38 |
| 70-1048-COM0157 | 15° Ti. Esthetic Abut., Posterior 4.5/5.0 | 22 | 70-1051-COM0199 | Ti. Esthetic Abut., Posterior WP | 38 |
| 70-1048-COM0158 | Ti. Esthetic Abut., Anterior 3.0 | 22 | (Straumann® Bone Level) | | |
| 70-1048-COM0159 | Ti. Esthetic Abut., Anterior 3.5/4.0 | 22 | 70-1052-COM0089 | 15° Ti. Esthetic Abut., Anterior NC | 41 |
| | | | 70-1052-COM0090 | 15° Ti. Esthetic Abut., Anterior RC | 41 |

Parts Index

| CODE | DESCRIPTION | PAGE | CODE | DESCRIPTION | PAGE |
|--|--|------|------|-------------|------|
| 70-1052-COM0091 |15° Ti. Esthetic Abut., Posterior RC..... | 41 | | | |
| 70-1052-COM0092 |Ti. Esthetic Abut., Anterior NC..... | 42 | | | |
| 70-1052-COM0093 |Ti. Esthetic Abut., Anterior RC..... | 42 | | | |
| 70-1052-COM0094 |Ti. Esthetic Abut., Posterior RC..... | 42 | | | |
| TITANIUM SCREWS AND GUIDE PINS | | | | | |
| (BIOMET 3i™ Certain®) | | | | | |
| 70-1047-COM0117 | Titanium Screw 3.4/4.1/5.0/6.0 mm..... | 13 | | | |
| 70-1047-COM0029 |Titanium Screw (5/pk) 3.4/4.1/5.0/6.0 mm..... | 13 | | | |
| 70-1047-COM0112 |Guide Pin (5/pk) 3.4/4.1/5.0/6.0 mm..... | 13 | | | |
| (CAMLOG® SCREW-LINE) | | | | | |
| 70-1135-CAM0125 |Titanium Screw (5/pk) 3.3/3.8/4.3 mm..... | 17 | | | |
| 70-1135-CAM0127 |Titanium Screw (5/pk) 5.0/6.0 mm..... | 17 | | | |
| 70-1135-CAM0124 |Titanium Screw 3.3/3.8/4.3 mm..... | 17 | | | |
| 70-1135-CAM0126 |Titanium Screw 5.0/6.0 mm..... | 17 | | | |
| 70-1135-CAM0064 |Guide Pin (5/pk) 3.3/3.8/4.3 mm..... | 17 | | | |
| 70-1135-CAM0066 |Guide Pin (5/pk) 5.0/6.0 mm..... | 17 | | | |
| (DENTSPLY Implants Ankylos® C/X) | | | | | |
| 70-1139-COM0057 |Guide Pin (5/pk) C/X..... | 19 | | | |
| 70-1139-COM0019 |Titanium Screw (5/pk) C/X..... | 19 | | | |
| 70-1139-COM0014 |Titanium Screw C/X..... | 19 | | | |
| (DENTSPLY Implants ASTRA TECH Implant System®) | | | | | |
| 70-1048-COM0031 |Titanium Screw (5/pk) 3.0..... | 22 | | | |
| 70-1048-COM0033 |Titanium Screw (5/pk) 3.5/4.0..... | 22 | | | |
| 70-1048-COM0036 |Titanium Screw (5/pk) 4.5/5.0..... | 22 | | | |
| 70-1048-COM0121 |Titanium Screw 3.0..... | 22 | | | |
| 70-1048-COM0122 |Titanium Screw 3.5/4.0..... | 22 | | | |
| 70-1048-COM0123 |Titanium Screw 4.5/5.0..... | 22 | | | |
| 70-1048-COM0110 |Guide Pin (5/pk) 3.0..... | 23 | | | |
| 70-1048-COM0112 |Guide Pin (5/pk) 3.5/4.0..... | 23 | | | |
| 70-1048-COM0114 |Guide Pin (5/pk) 4.5/5.0..... | 23 | | | |
| (DENTSPLY Implants ASTRA TECH Implant System® EV) | | | | | |
| 70-1176-COM0254 |Titanium Screw 3.0..... | 25 | | | |
| 70-1176-COM0255 |Titanium Screw 3.6..... | 25 | | | |
| 70-1176-COM0256 |Titanium Screw 4.2..... | 25 | | | |
| 70-1176-COM0257 |Titanium Screw 4.8..... | 25 | | | |
| 70-1176-COM0258 |Titanium Screw 5.4..... | 25 | | | |
| 70-1176-COM0312 |Guide Pin 3.0..... | 26 | | | |
| 70-1176-COM0313 |Guide Pin 3.6..... | 26 | | | |
| 70-1176-COM0314 |Guide Pin 4.2..... | 26 | | | |
| 70-1176-COM0315 |Guide Pin 4.8/5.4..... | 26 | | | |
| (Hiossen® HG System) | | | | | |
| 70-1147-COM0011 |Titanium Screw Standard..... | 27 | | | |
| 70-1147-COM0010 |Titanium Screw Mini..... | 27 | | | |
| 70-1147-COM0015 |Titanium Screw (5/pk) Standard..... | 27 | | | |
| 70-1147-COM0014 |Titanium Screw (5/pk) Mini..... | 27 | | | |
| 70-1147-COM0083 |Guide Pin (5/pk) Standard..... | 28 | | | |
| 70-1147-COM0084 |Guide Pin (5/pk) Mini..... | 28 | | | |
| 70-1147-COM0093 |Titanium Screw Standard..... | 28 | | | |
| 70-1147-COM0094 |Titanium Screw Mini..... | 28 | | | |
| (Inclusive® Tapered Implant System) | | | | | |
| 70-1072-PRC0005 |Closed-Tray Transfer Screw..... | 8 | | | |
| 70-1072-PRC0004 |Open-Tray Transfer Screw..... | 8 | | | |
| 70-1072-PRC0058 |Titanium Screw 3.0 mmP..... | 8 | | | |
| 70-1072-PRC0057 |Titanium Screw 3.0 mmP (5/pk)..... | 8 | | | |
| 70-1072-PRC0001 |Titanium Screw..... | 8 | | | |
| 70-1072-PRC0003 |Titanium Screw (5/pk)..... | 8 | | | |
| 70-1072-PRC0056 |Guide Pin 3.0 mmP (5/pk)..... | 8 | | | |
| 70-1072-PRC0002 |Guide Pin (5/pk)..... | 8 | | | |
| (MegaGen AnyRidge® Implant System) | | | | | |
| 70-1173-COM0004 |Titanium Screw..... | 30 | | | |
| 70-1173-COM0001 |Titanium Screw..... | 30 | | | |
| 70-1173-COM0018 |Guide Pin (5/pk)..... | 30 | | | |
| (Nobel Biocare Brånemark System®) | | | | | |
| 70-1049-COM0040 |Titanium Screw RP..... | 33 | | | |
| 70-1049-COM0011 |Titanium Screw (5/pk) RP..... | 33 | | | |
| (NobelActive®) | | | | | |
| 70-1050-COM0064 |Titanium Screw NP..... | 35 | | | |
| 70-1050-COM0010 |Titanium Screw (5/pk) NP..... | 35 | | | |
| 70-1050-COM0065 |Titanium Screw RP..... | 35 | | | |
| 70-1050-COM0011 |Titanium Screw (5/pk) RP..... | 35 | | | |
| 70-1050-COM0060 |Guide Pin Implant Level 20 mm (5/pk) NP..... | 35 | | | |
| 70-1050-COM0061 |Guide Pin Implant Level 20 mm (5/pk) RP..... | 35 | | | |
| (NobelReplace®) | | | | | |
| 70-1051-COM0153 |Titanium Screw NP..... | 39 | | | |
| 70-1051-COM0019 |Titanium Screw (5/pk) NP..... | 39 | | | |
| 70-1051-COM0154 |Titanium Screw RP/WP/6.0..... | 39 | | | |
| 70-1051-COM0020 |Titanium Screw (5/pk) RP/WP/6.0..... | 39 | | | |
| 70-1051-COM0142 |Guide Pin Implant Level 20 mm (5/pk) NP..... | 40 | | | |
| 70-1051-COM0144 |Guide Pin Implant Level 20 mm (5/pk) RP/WP/6.0..... | 40 | | | |
| (Straumann® Bone Level) | | | | | |
| 70-1052-COM0064 |Titanium Screw NC..... | 42 | | | |
| 70-1052-COM0020 |Titanium Screw (5/pk) NC..... | 42 | | | |
| 70-1052-COM0065 |Titanium Screw RC..... | 42 | | | |
| 70-1052-COM0021 |Titanium Screw (5/pk) RC..... | 42 | | | |
| 70-1052-COM0059 |Guide Pin (5/pk) NC..... | 42 | | | |
| 70-1052-COM0061 |Guide Pin (5/pk) RC..... | 42 | | | |
| (Straumann® Tissue Level) | | | | | |
| 70-1053-COM0035 |Titanium Occlusal Screw NN..... | 44 | | | |
| 70-1053-COM0036 |Titanium Occlusal Screw (5/pk) NN..... | 44 | | | |
| 70-1053-COM0034 |Titanium Basal Screw RN/WN synOcta..... | 44 | | | |
| 70-1053-COM0009 |Titanium Basal Screw (5/pk) RN/WN synOcta..... | 44 | | | |
| (Zimmer Dental Screw-Vent®) | | | | | |
| 70-1054-COM0048 |Titanium Screw 3.5/4.5/5.7 mm..... | 46 | | | |
| 70-1054-COM0022 |Titanium Screw (5/pk) 3.5/4.5/5.7 mm..... | 46 | | | |
| 70-1054-COM0084 |Guide Pin (5/pk) 3.5/4.5/5.7 mm..... | 46 | | | |
| UCLA ABUTMENTS | | | | | |
| (BIOMET 3i™ Certain®) | | | | | |
| 70-1047-COM0165 |UCLA Plastic Abutment 3.4 mm..... | 13 | | | |
| 70-1047-COM0166 |UCLA Plastic Abutment 4.1 mm..... | 13 | | | |

Parts Index

| CODE | DESCRIPTION | PAGE | CODE | DESCRIPTION | PAGE |
|---|---|------|------------------------------------|---|------|
| 70-1047-COM0167 |UCLA Plastic Abutment 5.0 mm | 13 | 70-1051-COM0207 |UCLA Plastic Abutment, Non-Engag, WP | 39 |
| 70-1047-COM0168 |UCLA Plastic Abutment 6.0 mm | 13 | 70-1051-COM0208 |UCLA Plastic Abutment, Non-Engag, 6.0 | 39 |
| 70-1047-COM0169 |UCLA Plastic Abutment, Non-Engag, 3.4 mm | 13 | (Straumann® Bone Level) | | |
| 70-1047-COM0170 |UCLA Plastic Abutment, Non-Engag, 4.1 mm | 13 | 70-1052-COM0095 |UCLA Plastic Abutment NC | 42 |
| 70-1047-COM0171 |UCLA Plastic Abutment, Non-Engag, 5.0 mm | 13 | 70-1052-COM0096 |UCLA Plastic Abutment RC | 42 |
| 70-1047-COM0172 |UCLA Plastic Abutment, Non-Engag, 6.0 mm | 13 | 70-1052-COM0097 |UCLA Plastic Abutment, Non-Engag, NC | 42 |
| (CAMLOG® SCREW-LINE) | | | 70-1052-COM0098 |UCLA Plastic Abutment, Non-Engag, RC | 42 |
| 70-1135-CAM0163 |UCLA Plastic Abutment, Non-Engag, 3.3 mm | 17 | (Zimmer Dental Screw-Vent®) | | |
| 70-1135-CAM0164 |UCLA Plastic Abutment, Non-Engag, 3.8 mm | 17 | 70-1054-COM0100 |UCLA Plastic Abutment 3.5 mm | 46 |
| 70-1135-CAM0165 |UCLA Plastic Abutment, Non-Engag, 4.3 mm | 17 | 70-1054-COM0101 |UCLA Plastic Abutment 4.5 mm | 46 |
| 70-1135-CAM0166 |UCLA Plastic Abutment, Non-Engag, 5.0 mm | 17 | 70-1054-COM0102 |UCLA Plastic Abutment 5.7 mm | 46 |
| 70-1135-CAM0167 |UCLA Plastic Abutment, Non-Engag, 6.0 mm | 17 | 70-1054-COM0103 |UCLA Plastic Abutment, Non-Engag, 3.5 mm | 46 |
| (DENTSPLY Implants Ankylos® C/X) | | | 70-1054-COM0104 |UCLA Plastic Abutment, Non-Engag, 4.5 mm | 46 |
| 70-1139-COM0047 |UCLA Plastic Abutment, Non-Engag, C/ | 19 | 70-1054-COM0105 |UCLA Plastic Abutment, Non-Engag, 5.7 mm | 46 |
| (DENTSPLY Implants ASTRA TECH Implant System®) | | | | | |
| 70-1048-COM0163 |UCLA Plastic Abutment 3.0 | 22 | | | |
| 70-1048-COM0164 |UCLA Plastic Abutment 3.5/4.0 | 22 | | | |
| 70-1048-COM0165 |UCLA Plastic Abutment 4.5/5.0 | 22 | | | |
| 70-1048-COM0166 |UCLA Plastic Abutment, Non-Engag, 3.0 | 22 | | | |
| 70-1048-COM0167 |UCLA Plastic Abutment, Non-Engag, 3.5/4.0 | 22 | | | |
| 70-1048-COM0168 |UCLA Plastic Abutment, Non-Engag, 4.5/5.0 | 22 | | | |
| (Hiossen® HG System) | | | | | |
| 70-1147-COM0058 |UCLA Plastic Abutment Standard | 27 | | | |
| 70-1147-COM0059 |UCLA Plastic Abutment Mini | 27 | | | |
| 70-1147-COM0056 |UCLA Plastic Abutment, Non-Engag, Standard | 27 | | | |
| 70-1147-COM0057 |UCLA Plastic Abutment, Non-Engag, Mini | 27 | | | |
| (Inclusive® Tapered Implant System) | | | | | |
| 70-1073-PRA0058 |UCLA Plastic Abutment 3.0 mmP | 7 | | | |
| 70-1073-PRA0018 |UCLA Plastic Abutment 3.5 mmP | 7 | | | |
| 70-1073-PRA0020 |UCLA Plastic Abutment 4.5 mmP | 7 | | | |
| 70-1073-PRA0057 |UCLA Plastic Abutment, Non-Engag, 3.0 mmP | 7 | | | |
| 70-1073-PRA0019 |UCLA Plastic Abutment, Non-Engag, 3.5 mmP | 7 | | | |
| 70-1073-PRA0021 |UCLA Plastic Abutment, Non-Engag, 4.5 mmP | 7 | | | |
| (MegaGen AnyRidge® Implant System) | | | | | |
| 70-1173-COM0017 |UCLA Plastic Abutment | 30 | | | |
| 70-1173-COM0016 |UCLA Plastic Abutment, Non-Engag | 30 | | | |
| (Nobel Biocare Brånemark System®) | | | | | |
| 70-1049-COM0063 |UCLA Plastic Abutment RP | 32 | | | |
| 70-1049-COM0064 |UCLA Plastic Abutment, Non-Engag, RP | 32 | | | |
| (NobelActive®) | | | | | |
| 70-1050-COM0097 |UCLA Plastic Abutment NP | 35 | | | |
| 70-1050-COM0098 |UCLA Plastic Abutment RP | 35 | | | |
| 70-1050-COM0099 |UCLA Plastic Abutment, Non-Engag, NP | 35 | | | |
| 70-1050-COM0100 |UCLA Plastic Abutment, Non-Engag, RP | 35 | | | |
| (NobelReplace®) | | | | | |
| 70-1051-COM0201 |UCLA Plastic Abutment NP | 39 | | | |
| 70-1051-COM0202 |UCLA Plastic Abutment RP | 39 | | | |
| 70-1051-COM0203 |UCLA Plastic Abutment WP | 39 | | | |
| 70-1051-COM0204 |UCLA Plastic Abutment 6.0 | 39 | | | |
| 70-1051-COM0205 |UCLA Plastic Abutment, Non-Engag, NP | 39 | | | |
| 70-1051-COM0206 |UCLA Plastic Abutment, Non-Engag, RP | 39 | | | |

Product Packaging

Inclusive Prosthetic Components are delivered in boxed blister trays or heat-sealed plastic pouches. They may be stored in a dry location at room temperature in this original packaging. Please refer to the individual product label for all relevant product information and cautions. Products labeled **STERILE** are intended for single-use only, prior to the expiration date. Do not use sterile products if the packaging has been compromised or previously opened. Do not re-sterilize. Products labeled **NON-STERILE** should be cleaned, disinfected, and sterilized according to a validated method prior to use in the oral environment.

Explanation of Label Codes:

1. Official product description
2. Date of Manufacture (YYYY-MM-DD)
3. Catalog Number
4. Lot/Batch Number
5. By Prescription Only
6. Do Not Use if Package is Damaged
7. Sterile with Gamma Radiation
8. Use-by Date
9. Consult Instructions for Use
10. Do not Re-use
11. Do not Resterilize
12. Manufacturer
13. Country of origin
14. Unique Device Identification (UDI)
15. Non-Sterile
16. QR code for IFU website

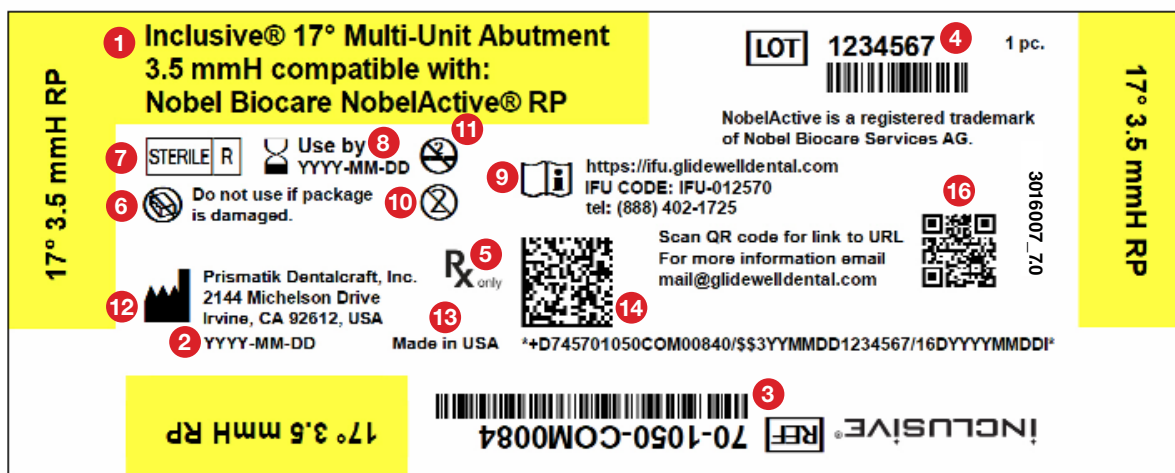
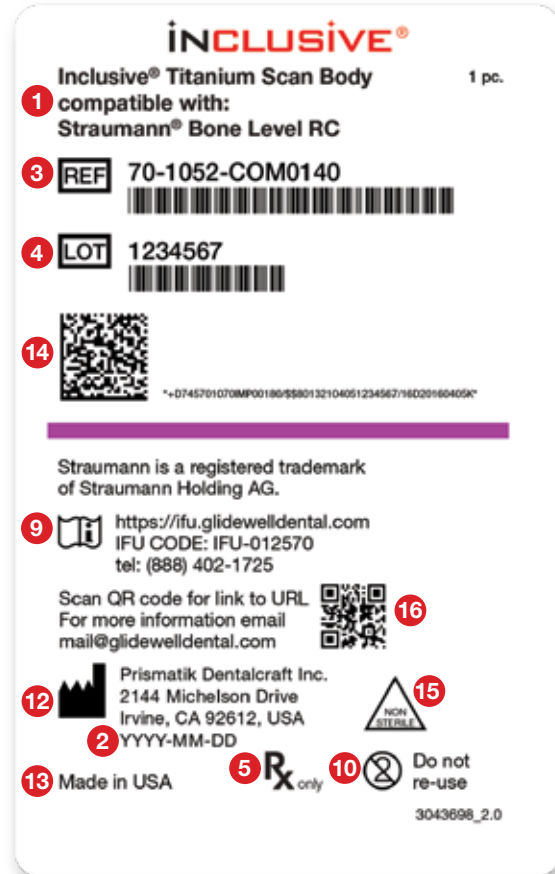

Policies and Warranty

ORDERING INFORMATION

In the U.S.: Order at glidewelldirect.com or call Glidewell Direct at 888-303-3975. Our product specialists are committed to answering questions in a timely fashion to ensure your ordering is easy and efficient. We are available Monday—Friday from 6 a.m.—5 p.m. (*Pacific*).

In Canada: Call 888-278-0414 to order. All others: Please send inquiries to: international@glidewelldirect.com.

SHIPPING POLICY

- Orders placed after 3 p.m. (*Pacific*) will be processed on the following business day. Business days do not include Saturdays, Sundays, or U.S. holidays.
- Online shopping cart available to U.S. customers only.

TERMS

All accounts are payable within 30 days of invoice date. Accounts not paid within the stated terms will be subject to COD status and a late charge of 2 percent of the unpaid balance. We accept American Express, Visa, MasterCard, and Discover. All prices are subject to change without notice.

PRODUCT RETURN POLICY

Products may be returned at the customer's expense for credit within 30 days of invoice date. All returned products must meet the following conditions:

- A copy of the original invoice must accompany the products.
- Products must be packaged to arrive at the seller's facility undamaged.
- Discontinued, obsolete, expired, damaged, or opened items will not be accepted for return.
- Amount credited will be based on invoice price, less 15 percent for restocking fee.
- Shipping charges are the responsibility of the customer and will not be credited.

PRODUCT & PRICING CHANGES

Because products and equipment are continually undergoing refinement in design and manufacturing methods, we reserve the right to improve, modify, or discontinue products and equipment or change pricing at any time without incurring any obligation and without prior notice.

WARRANTY

Limited Warranty—Prismatik Dentalcraft, Inc.

Prismatik Dentalcraft, Inc. ("Prismatik"), is the manufacturer of dental products (the "product"), including Inclusive® Dental Implants ("implants"). Prismatik and Glidewell Direct hereinafter are referred to collectively as Glidewell. For a period from the original purchase date of seven (7) years for implants and six (6) months for ceramic blanks and any other product ("the warranty period"), Glidewell will at its option replace or refund the purchase price of any product, to the original purchaser ("user"), that is returned due to defects in material and manufacture.

NO GUARANTEE OR WARRANTY IS IMPLIED OTHER THAN EXPRESSLY STATED, INCLUDING ANY IMPLIED WARRANTY OF MERCHANTABILITY OR FITNESS FOR A PARTICULAR PURPOSE.

Glidewell shall not be liable for any incidental or consequential damages, whether foreseeable or not, caused by defects in the product or dental devices produced using said product. User is responsible for determining the suitability of the product for user's application. If this product is defective within the warranty period, user's exclusive remedy and Glidewell's sole obligation shall be replacement or refund of the purchase price of the product. For replacement or refund under this warranty, the original purchaser shall send the product at its own expense, postage prepaid, to Glidewell Direct, 18651 Von Karman Ave, Irvine, CA 92612.

INCLUSIVE[®]

PROSTHETIC COMPONENTS



Designed & Manufactured
in the USA



PRISMATIK
DENTALCRAFT, INC.

2144 Michelson Drive • Irvine, CA 92612, USA